

**TRAMONTINA**

**Housewares**  
Utilidades



**2022**

## TRAMONTINA

More than just numbers, what truly defines Tramontina is the constant effort to make people's lives better. The small iron mill founded by Valentin and Elisa Tramontina in 1911 in southern Brazil was the beginning of a group that now encompasses 10 manufacturing units and has kept the century-old tradition of delighting people with simple gestures. The secret for maintaining this essence is believing in people. Tramontina values each one of its over 10,000 employees so they can deliver functional, stylish products to the market, bringing inspiration to people's daily living and creating experiences to generate value and satisfy clients, consumers and communities. All this is apparent in the more than 22,000 items that carry the values of a unique brand. Kitchen utensils and equipment, appliances, tools for agriculture, gardening, industrial and automotive maintenance, construction, electrical hardware, wood and plastic furniture, and a wide range of ride-on equipment is manufactured for the domestic market and exported to over 120 countries. It is by doing beautiful things well that Tramontina and people are brought together. A global player, the company finds the necessary support to deliver solutions that can meet contemporary demands, combining productivity and going over and beyond targets for sustainable development through the environmental management program.

### Pleased to meet you, Tramontina!

Más que números, lo que define a Tramontina es el esfuerzo permanente para mejorar cada vez más la vida de la gente. La pequeña herrería fundada por Valentin y Elisa Tramontina en 1911, en el sur de Brasil, originó un grupo que hoy cuenta con 10 unidades fabriles y mantiene la vocación centenaria de encantar con gestos sencillos. El secreto para mantener la esencia es creer en las personas. Tramontina valora a cada uno de los más de 10 mil empleados para que le entreguen al mercado productos funcionales y con estilo, que inspiran el día a día y estimulan experiencias para generar valor y satisfacción a clientes, consumidores y comunidades. Todo eso se traduce en los más de 22 mil artículos que llevan los valores de una marca única. Utensilios y equipos de cocina, electrodomésticos, herramientas para agricultura, jardinería, mantenimiento industrial y automovilístico, construcción civil, materiales eléctricos, muebles de madera o de plástico, además de la amplia línea de equipos dirigibles, que se fabrican para el mercado nacional y de exportación para más de 120 países. Es en el hacer bien las cosas que se encuentran Tramontina y las personas. Actuando de forma global, la marca tiene el soporte necesario para entregar soluciones capaces de atender las necesidades de su tiempo, aliando productividad y superación de metas de desarrollo sustentable por medio del programa de gestión ambiental.

### ¡Encantada, Tramontina!

TRAMONTINA





**LEARN HOW / SEPA POR QUÉ**

# **FARROUPILHA**

**DOES THINGS BEAUTIFULLY WELL /  
SABE HACER BIEN LAS COSAS**

Tramontina Farroupilha was founded in 1971 and is located in the city of Farroupilha, in the state of Rio Grande do Sul, Brazil. It now has an industrial area of over 100,000 m<sup>2</sup> and more than 700 employees who manufacture stainless steel products ranging from pans, serving sets, and tableware to high-technology professional kitchen equipment. The three ISO certificates obtained by Farroupilha are the proof of the level of quality that not only can be found in the products made at Farroupilha, but also in a well-constituted organization: ISO 14001 [Environmental Management Systems], ISO 9001 [Quality Management System], and ISO OHSAS [Occupational Health and Safety].

Quality, design, shine, and beauty are the distinguishing features of the products made at this unit, and are present in professional kitchens that offer assurance and safety to chefs and gastronomy professionals alike. Products that do things beautifully well in the kitchen and at the table with one's family and guests.

---

Tramontina Farroupilha, fundada en 1971, está ubicada en Farroupilha, Rio Grande do Sul. Esta unidad fabril, que hoy cuenta con 100 mil m<sup>2</sup> de área construida, tiene más de 700 empleados que se ocupan de fabricar productos de acero inoxidable: desde ollas, vajilla y cubiertos hasta sistemas de cocinas profesionales de alta tecnología. La obtención de las tres certificaciones ISO por Farroupilha comprueba el nivel de calidad tanto de los productos como de los ambientes y de la organización: ISO 14.001 [Sistema de Gestión Ambiental], ISO 9.001 [Sistema de Gestión de la Calidad] e ISO OHSAS [Salud y Seguridad Laboral].

Calidad, diseño y brillo son características definidas de los productos de esta unidad, que están presentes tanto en las cocinas profesionales que les ofrecen garantía y seguridad a los chefs de cocina y a los profesionales de gastronomía, como en los productos para lucirse en la cocina y en la mesa, con la familia o con los invitados.

# SUMMARY SUMARIO

06

## PREPARING AND STORING SERVIR PREPARAR Y GUARDAR

Bowls • Canisters  
Recipientes • Contenedor

26

## ACCESSORIES ACCESORIOS

Dish rack • Cruet set • Napkin holder  
Kitchen scale • Salt and pepper grinder

Escurridor para platos • Vinagrera con saleros  
Porta servilletas • Balanza de cocina • Molinillo  
de sal o pimienta

62

## OVEN AND STOVE COCINA Y HORNO

Sauce Pan • Casserole • Frying Pan  
Pressure cooker • Pizza Pan

Olla • Cacerola • Sartén  
Olla A Presión • Asadera De Pizza

157

## TABLEWARE MESA

High End Flatware • Everyday  
Flatware • Flatware sets

Cubiertos finos • Cubiertos de uso  
diario • Juegos de cubiertos

253

## SERVING SERVIR

Tray • Platter • Butter dish  
Fruit bowl • Serving set

Bandeja • Fuente llana • Mantequillera  
Frutero • Juego para servir

---

# 272

## **THERMAL BEVERAGE DISPENSERS TERMOS**

Vacuum insulated bottle  
Tritan bottle

Termo • Botella tritan

---

# 287

## **TEA AND COFFEE TÉ Y CAFÉ**

Coffee Pot • Coffee Grinder  
Pitcher • Tea kettle • Covered milk  
pot • Sugar bowl

Coffee Grinder • Molinillo de Café  
Jarra • Tetera • Lechera • Azúcarero

---

# 309

## **BAR**

Straws • Ice bucket and wine/  
champagne • Cocktail shaker

Sorbete • Hielera • Balde para botellas  
Coctelera

---

# 331

## **CHILDREN INFANTIL**

Flatware set • Round dish • Cup

Juego de cubiertos • Plato • Vaso

---

# 351

## **HOSPITALITY**

Chafing dish • Gastronorm lids • Tray  
Utensils • Appetizer spoon

Rechaud • Tapas gastronómicas • Bandeja  
Utensilios • Cuchara de aperitivo

---

# 373

## **CHURRASCO ASADO**

Cutlery sets • Cooking grates  
Steak Knives

Juego de cubiertos • Asaderas  
Cuchillos para Asado



# PREPARING AND STORING

# PREPARAR Y GUARDAR

---



## ORGANIZATION AND HYGIENE

# MORE FREE TIME AND LESS WASTE

The durability of stainless steel takes center stage with a line of bowls and containers that let you do a wonderful job in your daily kitchen routine.

Available in different sizes, Tramontina's Freezinox line makes preparation easier and tends the shelf life of ingredients and prepared dishes, keeping them fresh and healthy for much longer.

## ORGANIZACIÓN E HIGIENE

# MÁS TIEMPO LIBRE Y MENOS DESPERDICIO

La durabilidad del acero inoxidable entra en escena en una línea de potes y recipientes que se luce en el día a día de la cocina.

Diponible en diversos tamaños, la línea Tramontina Freezinox facilita la preparación y prolonga la vida útil de ingredientes y alimentos preparados, manteniéndolos frescos y sanos por mucho más tiempo.



# FREEZINOX



FOOD STORAGE CONTAINER WITH  
PLASTIC LID  
CONTENEDOR PARA ALIMENTOS CON  
TAPA PLÁSTICA

	Ref.	Un.	m <sup>3</sup>	7891116
158 x 158mm - 1,20l	61221/164	06	0,019	137475
188 x 188mm - 2,40l	61221/194	04	0,020	137505
228 x 228mm - 4,00l	61221/234	04	0,028	137536



FOOD STORAGE CONTAINER WITH  
PLASTIC LID  
CONTENEDOR PARA ALIMENTOS CON  
TAPA PLÁSTICA

	Ref.	Un.	m <sup>3</sup>	7891116
158 x 158mm - 1,20l	61221/165	06	0,019	137482
188 x 188mm - 2,40l	61221/195	04	0,020	137512
228 x 228mm - 4,00l	61221/235	04	0,028	137543



FOOD STORAGE CONTAINER WITH  
PLASTIC LID  
CONTENEDOR PARA ALIMENTOS CON  
TAPA PLÁSTICA

	Ref.	Un.	m <sup>3</sup>	7891116
158 x 158mm - 1,20l	61221/167	06	0,019	008089
188 x 188mm - 2,40l	61221/197	04	0,020	137529
228 x 228mm - 4,00l	61221/237	04	0,028	137550



FOOD STORAGE CONTAINER WITH  
PLASTIC LID SET  
JUEGO DE CONTENEDORES PARA  
ALIMENTOS CON TAPA PLÁSTICA  
3 PC./PZAS.

	Ref.	Un.	m <sup>3</sup>	7891116
	64220/942	02	0,030	138809

Contents / Contenido:  
3 - 158 x 158mm - 1,20l



FOOD STORAGE CONTAINER WITH  
PLASTIC LID SET  
JUEGO DE CONTENEDORES PARA  
ALIMENTOS CON TAPA PLÁSTICA  
3 PC./PZAS.

	Ref.	Un.	m <sup>3</sup>	7891116
	64220/932	04	0,037	137567

Contents / Contenido:  
1 - 158 x 158mm - 1,20l  
1 - 188 x 188mm - 2,40l  
1 - 228 x 228mm - 4,00l





FOOD STORAGE CONTAINER WITH  
PLASTIC LID  
CONTENEDOR PARA ALIMENTOS CON  
TAPA PLÁSTICA

	Ref.	Un.	m <sup>3</sup>	7891116
162 x 82mm - 0,40l	61229/080	04	0,007	154090



FOOD STORAGE CONTAINER WITH  
PLASTIC LID  
CONTENEDOR PARA ALIMENTOS CON  
TAPA PLÁSTICA

	Ref.	Un.	m <sup>3</sup>	7891116
162x162mm - 0,80l	61229/560	06	0,011	150108
162x162mm - 1,24l	61229/160	06	0,017	043899
191 x 191mm - 2,12l	61229/190	06	0,024	043936
235 x 235mm - 3,68l	61229/230	06	0,035	043974



FOOD STORAGE CONTAINER WITH  
PLASTIC LID SET  
JUEGO DE CONTENEDORES PARA  
ALIMENTOS CON TAPA PLÁSTICA  
3 PC./PZAS.

	Ref.	Un.	m <sup>3</sup>	7891116
	64220/920	04	0,028	080696

Contents / Contenido:  
1 - 162 x 162mm - 1,24l  
1 - 191 x 191mm - 2,12l  
1 - 235 x 235mm - 3,68l



MIXING BOWL WITH PLASTIC LID  
RECIPIENTE REDONDO CON TAPA PLÁSTICA

	Ref.	Un.	m <sup>3</sup>	7891116
Ø 9cm - 0,30l	61222/090	06	0,006	148600
Ø 14cm - 0,80l	61222/140	04	0,010	148624
Ø 18cm - 1,62l	61222/180	06	0,024	043844
Ø 20cm - 2,22l	61222/200	06	0,035	043851
Ø 22cm - 2,90l	61222/220	06	0,043	043868
Ø 25cm - 4,20l	61222/250	04	0,040	043875
Ø 28cm - 5,80l	61222/280	04	0,046	043882



Exclusive material for legal entities/corporate clients.  
Material exclusivo para clientes persona jurídica.



MIXING BOWL WITHOUT LID  
RECIPIENTE SIN TAPA

	Ref.	Un.	m <sup>3</sup>	7891116
Ø 9cm - 0,30l	61220/091*	10	0,006	148617
Ø 14cm - 0,80l	61220/141*	06	0,006	148631
Ø 18cm - 1,62l	61220/181*	12	0,013	016251
Ø 20cm - 2,22l	61220/201*	12	0,012	016268
Ø 22cm - 2,90l	61220/221*	12	0,012	016275
Ø 25cm - 4,20l	61220/251*	12	0,027	016282
Ø 28cm - 5,80l	61220/281*	12	0,030	016299



MIXING BOWLS WITH PLASTIC LID SET  
JUEGO DE RECIPIENTES CON TAPA  
PLÁSTICA  
3 PC./PZAS

	Ref.	Un.	m <sup>3</sup>	7891116
	64220/180	03	0,012	149140

Contents / Contenido:  
3 - Ø 9cm - 0,30l



MIXING BOWLS WITH PLASTIC LID SET  
JUEGO DE RECIPIENTES CON TAPA  
PLÁSTICA  
3 PC./PZAS

	Ref.	Un.	m <sup>3</sup>	7891116
	64220/190	02	0,017	149157

Contents / Contenido:  
3 - Ø 14cm - 0,80l



MIXING BOWLS WITH PLASTIC LID SET  
JUEGO DE RECIPIENTES CON TAPA  
PLÁSTICA  
3 PC./PZAS

	Ref.	Un.	m <sup>3</sup>	7891116
	64220/150	02	0,028	149164

Contents / Contenido:  
1 - Ø 9cm - 0,30l  
1 - Ø 14cm - 0,80l  
1 - Ø 18cm - 1,62l



MIXING BOWLS WITH PLASTIC LID SET  
JUEGO DE RECIPIENTES CON TAPA  
PLÁSTICA  
3 PC./PZAS

	Ref.	Un.	m <sup>3</sup>	7891116
	64220/160	02	0,045	149171

Contents / Contenido:  
1 - Ø 14cm - 0,80l  
1 - Ø 18cm - 1,62l  
1 - Ø 20cm - 2,22l

\*No packaging / Sin embalaje

Exclusive material for legal entities/corporate clients.  
Material exclusivo para clientes persona jurídica.





MIXING BOWLS WITH PLASTIC LID SET  
 JUEGO DE RECIPIENTES CON TAPA PLÁSTICA  
 2 PC./PZAS.

Ref.	Un.	m <sup>3</sup>	7891116
64220/130	02	0,025	118146

Contents / Contenido:  
 1 - Ø 18cm - 1,62l  
 1 - Ø 20cm - 2,22l



MIXING BOWLS WITH PLASTIC LID SET  
 JUEGO DE RECIPIENTES CON TAPA PLÁSTICA  
 3 PC./PZAS.

Ref.	Un.	m <sup>3</sup>	7891116
64220/010	02	0,060	030202

Contents / Contenido:  
 1 - Ø 18cm - 1,62l  
 1 - Ø 20cm - 2,22l  
 1 - Ø 22cm - 2,90l



MIXING BOWLS WITH PLASTIC LID SET  
 JUEGO DE RECIPIENTES CON TAPA PLÁSTICA  
 3 PC./PZAS.

Ref.	Un.	m <sup>3</sup>	7891116
64220/210	04	0,028	080689

Contents / Contenido:  
 1 - Ø 18cm - 1,62l  
 1 - Ø 20cm - 2,22l  
 1 - Ø 22cm - 2,90l

# CUCINA



MIXING BOWL  
RECIPIENTE

	Ref.	Un.	m <sup>3</sup>	7891116
Ø 24cm - 2,80l	61224/241*	06	0,014	056301
Ø 28cm - 4,70l	61224/281*	06	0,023	056318
Ø 32cm - 7,50l	61224/321*	06	0,030	056325
Ø 36cm - 12,30l	61224/361*	06	0,042	056332



MIXING BOWLS SET  
JUEGO DE RECIPIENTES  
2 PC./PZAS.

	Ref.	Un.	m <sup>3</sup>	7891116
	64220/220	02	0,030	118122

Contents / Contenido:  
1 - Ø 24cm - 2,80l  
1 - Ø 28cm - 4,70l





MIXING BOWL WITH PLASTIC LID  
RECIPIENTE REDONDO CON TAPA PLÁSTICA

	Ref.	Un.	m <sup>3</sup>	7891116
Ø 16cm - 1,60l	61228/160	04	0,024	030912
Ø 20cm - 3,00l	61228/200	04	0,042	030929
Ø 24cm - 5,20l	61228/240	04	0,070	030936
Ø 28cm - 8,30l	61228/280	04	0,101	030943



MIXING BOWL WITHOUT LID  
RECIPIENTE REDONDO SIN TAPA

	Ref.	Un.	m <sup>3</sup>	7891116
Ø 16cm - 1,60l	61228/161*	06	0,012	032176
Ø 20cm - 3,00l	61228/201*	06	0,027	032183
Ø 24cm - 5,20l	61228/241*	06	0,027	032190
Ø 28cm - 8,30l	61228/281*	06	0,049	032206
Ø 32cm - 12,70l	61228/321*	06	0,070	038727



MIXING BOWLS SET WITH PLASTIC LID  
JUEGO DE RECIPIENTES CON TAPA PLÁSTICA  
3 PC./PZAS.

	Ref.	Un.	m <sup>3</sup>	7891116
	64220/710	05	0,083	080702

Contents / Contenido:

- 1 - Ø 16cm - 1,60l
- 1 - Ø 20cm - 3,00l
- 1 - Ø 24cm - 5,20l

\*No packaging / Sin embalaje





CANISTER WITH PLASTIC LID  
CONTENEDOR CON TAPA PLÁSTICA

	Ref.	Un.	m <sup>3</sup>	7891116
Ø 12cm - 1,50l	61227/120	04	0,018	030875
Ø 14cm - 2,33l	61227/140	04	0,030	030882
Ø 16cm - 3,41l	61227/160	04	0,042	030899
Ø 18,5cm - 5,28l	61227/180	04	0,055	030905



CANISTER WITH PLASTIC LID SET  
JUEGO DE CONTENEDORES  
CON TAPA PLÁSTICA  
3 PC./PZAS.

	Ref.	Un.	m <sup>3</sup>	7891116
	64220/620	04	0,042	080719

Contents / Contenido:  
1 - Ø 12cm - 1,50l  
1 - Ø 14cm - 2,33l  
1 - Ø 16cm - 3,41l



CANISTER WITH PLASTIC LID SET  
JUEGO DE CONTENEDORES  
CON TAPA PLÁSTICA  
4 PC./PZAS.

	Ref.	Un.	m <sup>3</sup>	7891116
	64220/630	04	0,055	080726

Contents / Contenido:  
1 - Ø 12cm - 1,50l  
1 - Ø 14cm - 2,33l  
1 - Ø 16cm - 3,41l  
1 - Ø 18,5cm - 5,28l



CANISTER WITH PLASTIC LID  
CONTENEDOR CON TAPA PLÁSTICA

	Ref.	Un.	m <sup>3</sup>	7891116
Ø 12cm - 1,50l	61227/122	04	0,015	087213
Ø 14cm - 2,33l	61227/142	04	0,030	087244
Ø 16cm - 3,41l	61227/162	04	0,042	087275
Ø 18,5cm - 5,28l	61227/182	04	0,055	087305



CANISTER WITH PLASTIC LID  
CONTENEDOR CON TAPA PLÁSTICA

	Ref.	Un.	m <sup>3</sup>	7891116
Ø 14cm - 2,33l	61227/143	04	0,030	087251
Ø 16cm - 3,41l	61227/163	04	0,042	087282
Ø 18,5cm - 5,28l	61227/183	04	0,055	087312



CANISTER WITH PLASTIC LID  
CONTENEDOR CON TAPA PLÁSTICA

	Ref.	Un.	m <sup>3</sup>	7891116
Ø 14cm - 2,33l	61227/144	04	0,030	087268
Ø 16cm - 3,41l	61227/164	04	0,042	087299
Ø 18,5cm - 5,28l	61227/184	04	0,055	087329





# BY ME



VACUUM INSULATED FOOD JAR  
TERMO PARA ALIMENTOS

	Ref.	Un.	m <sup>3</sup>	7891116
Ø 8,8cm - 0,40l	61648/440*	04	0,007	157794



VACUUM INSULATED FOOD JAR  
TERMO PARA ALIMENTOS

	Ref.	Un.	m <sup>3</sup>	7891116
Ø 8,8cm - 0,40l	61648/445*	04	0,007	157787



PORTABLE FLATWARE SET  
JUEGO DE CUBIERTOS PORTÁTIL  
4 PC. / PZAS.

	Ref.	Un.	m <sup>3</sup>	7891116
	61229/005	08	0,012	157831

Contents / Contenido:  
1 Case / Estuche  
1 Fork / Tenedor  
1 Knife / Cuchillo  
1 Spoon / Cuchara



PORTABLE FLATWARE SET  
JUEGO DE CUBIERTOS PORTÁTIL  
4 PC. / PZAS.

	Ref.	Un.	m <sup>3</sup>	7891116
	61229/000	08	0,012	157824

Contents / Contenido:  
1 Case / Estuche  
1 Fork / Tenedor  
1 Knife / Cuchillo  
1 Spoon / Cuchara



FOOD STORAGE CONTAINER WITH PLASTIC LID CONTENEDOR PARA ALIMENTOS CON TAPA PLÁSTICA				
	Ref.	Un.	m <sup>3</sup>	7891116
0,80l	61229/565	05	0,012	159392



FOOD STORAGE CONTAINER WITH PLASTIC LID CONTENEDOR PARA ALIMENTOS CON TAPA PLÁSTICA				
	Ref.	Un.	m <sup>3</sup>	7891116
0,80l	61229/567	05	0,012	159415



FOOD STORAGE CONTAINER WITH PLASTIC LID CONTENEDOR PARA ALIMENTOS CON TAPA PLÁSTICA				
	Ref.	Un.	m <sup>3</sup>	7891116
0,40l	61229/085	08	0,012	159385



FOOD STORAGE CONTAINER WITH PLASTIC LID CONTENEDOR PARA ALIMENTOS CON TAPA PLÁSTICA				
	Ref.	Un.	m <sup>3</sup>	7891116
0,40l	61229/087	08	0,012	159408





Exclusive material for legal entities/corporate clients.  
Material exclusivo para clientes persona jurídica.



		FOOD STORAGE CONTAINER CONTENEDOR PARA ALIMENTOS			
		Ref.	Un.	m <sup>3</sup>	7891116
167 x 127mm - 0,70l		61229/030*	04	0,012	158340



		FOOD STORAGE CONTAINER CONTENEDOR PARA ALIMENTOS			
		Ref.	Un.	m <sup>3</sup>	7891116
167 x 127mm - 0,70l		61229/035*	04	0,012	158364



		FOOD STORAGE CONTAINER CONTENEDOR PARA ALIMENTOS			
		Ref.	Un.	m <sup>3</sup>	7891116
189 x 129mm - 1,00l		61229/040*	04	0,012	158357



		FOOD STORAGE CONTAINER CONTENEDOR PARA ALIMENTOS			
		Ref.	Un.	m <sup>3</sup>	7891116
189 x 129mm - 1,00l		61229/045*	04	0,012	158371

# PUREZZA

96mm



GLASS STORAGE CONTAINER WITH  
STEEL LID  
CONTENEDOR DE VIDRIO CON TAPA DE  
ACERO

	Ref.	Un.	m <sup>3</sup>	7891116
Ø 10cm - 0,40l	61227/010*	04	0,014	155653

139mm



GLASS STORAGE CONTAINER WITH  
STEEL LID  
CONTENEDOR DE VIDRIO CON TAPA DE  
ACERO

	Ref.	Un.	m <sup>3</sup>	7891116
Ø 10cm - 0,70l	61227/020*	04	0,020	155660

180mm



GLASS STORAGE CONTAINER WITH  
STEEL LID  
CONTENEDOR DE VIDRIO CON TAPA DE  
ACERO

	Ref.	Un.	m <sup>3</sup>	7891116
Ø 10cm - 1,00l	61227/030*	04	0,030	155677

229mm



GLASS STORAGE CONTAINER WITH  
STEEL LID  
CONTENEDOR DE VIDRIO CON TAPA DE  
ACERO

	Ref.	Un.	m <sup>3</sup>	7891116
Ø 10cm - 1,40l	61227/040*	04	0,030	155684



287mm



GLASS STORAGE CONTAINER WITH  
STEEL LID  
CONTENEDOR DE VIDRIO CON TAPA DE  
ACERO

	Ref.	Un.	m <sup>3</sup>	7891116
Ø 10cm - 1,80l	61227/050*	04	0,025	155691



Exclusive material for legal entities/corporate clients.  
Material exclusivo para clientes persona jurídica.

\* Imported Product / Producto Importado



90mm



GLASS STORAGE CONTAINER  
WITH VACUUM SEALED LID  
CONTENEDOR DE VIDRIO  
CON TAPA A VACÍO

	Ref.	Un.	m <sup>3</sup>	7891116
Ø 11cm - 0,40l	61225/040*	02	0,010	144411

130mm



GLASS STORAGE CONTAINER  
WITH VACUUM SEALED LID  
CONTENEDOR DE VIDRIO  
CON TAPA A VACÍO

	Ref.	Un.	m <sup>3</sup>	7891116
Ø 11cm - 0,80l	61225/080*	02	0,010	144428

170mm



GLASS STORAGE CONTAINER  
WITH VACUUM SEALED LID  
CONTENEDOR DE VIDRIO  
CON TAPA A VACÍO

	Ref.	Un.	m <sup>3</sup>	7891116
Ø 11cm - 1,20l	61225/120*	02	0,017	144435



GLASS STORAGE CONTAINERS  
WITH VACUUM SEALED LID SET  
JUEGO DE CONTENEDORES DE  
VIDRIO CON TAPA A VACÍO  
3 PC./PZAS.

	Ref.	Un.	m <sup>3</sup>	7891116
	64220/750*	03	0,047	144442

Contents / Contenido:  
1 - Ø 11cm - 0,40l  
1 - Ø 11cm - 0,80l  
1 - Ø 11cm - 1,20l





# ACCESSORIES

# ACCESORIOS

---



Exclusive material for legal entities/corporate clients.  
Material exclusivo para clientes persona jurídica.

## FUNCTIONAL DESIGN

# PRODUCTS THAT BRING CONVENIENCE TO YOUR DAILY LIFE

This line was created to add convenience and sophistication to those daily routine tasks, such as preparing, seasoning, serving, handling and washing.

From spoons, ladles and spatulas to grinders, napkin holders and special utensils, Tramontina's accessories are essential for those who take pleasure in doing things beautifully at the table, on the stovetop or in the oven.

## DISEÑO FUNCIONAL

# PRODUCTOS PARA FACILITAR LA VIDA

Una línea creada para realzar la practicidad y sofisticación de aquellas tareas que son parte de la rutina diaria, como preparar, condimentar, servir, manejar y lavar.

Desde cucharas, cucharones y espátulas hasta molinillos, servilleteros y utensilios especiales, los accesorios Tramontina son indispensables para los que tienen placer en lucirse en la mesa, en el horno o en la cocina.





# PLURALE



Compact version  
Versión cerrada



Expanded version  
Versión abierta



For storing  
Versión desarmada

## MINI DISH DRAINER RACK MINIESCURRIDOR DE VAJILLAS

Ref.	Un.	m <sup>3</sup>	7891116
61537/000*	04	0,031	169070



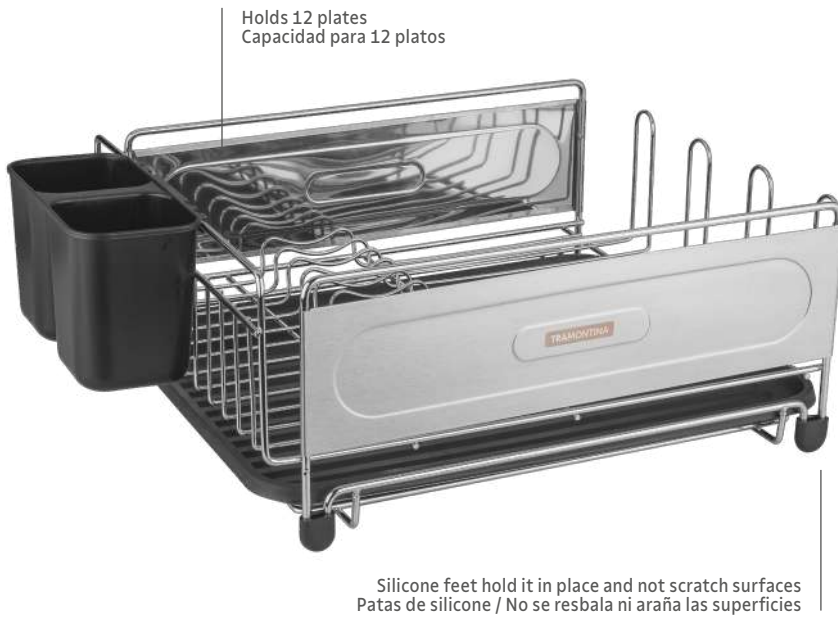

**DISH RACK WITH DRIP TRAY  
ESCURRIDOR CON BANDEJA  
PARA VAJILLA**

Ref.	Un.	m <sup>3</sup>	7891116
61536/000*	06	0,125	160046

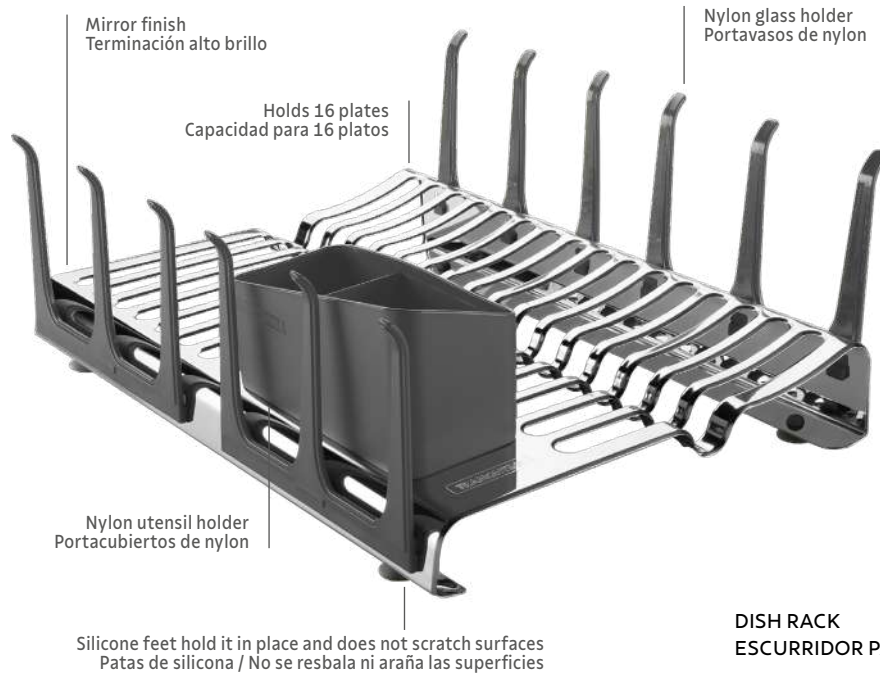

**DISH RACK  
ESCURRIDOR PARA PLATOS**

Ref.	Un.	m <sup>3</sup>	7891116
61535/530	03	0,048	100806



DISH DRAIN BOARD  
BANDEJA PARA VAJILLAS

Ref.	Un.	m <sup>3</sup>	7891116
61535/730	10	0,048	112625



DISH RACK WITH DRIP TRAY  
ESCURRIDOR CON BANDEJA PARA  
VAJILLA

Ref.	Un.	m <sup>3</sup>	7891116
61535/030	03	0,070	110133







Holds 16 plates  
Capacidad para 16 platos

Utensil holder: fits in the dish rack with the option of several positions  
Porta cubiertos: Se encaja en el cuerpo del escurridor con opción de posición

Flat base: To hold glasses, cups and various utensils  
Base plana: Para acomodar vasos, tazas y diferentes utensilios

Silicone feet hold it in place and does not scratch surfaces  
Patatas de silicona / No se resbala ni araña las superficies

## DISH RACK ESCURRIDOR PARA PLATOS

	Ref.	Un.	m <sup>3</sup>	7891116
■	61530/000	02	0,085	064900
■	61530/010	02	0,085	068137
□	61530/100	02	0,085	068144





# ADATTO



NEW RELEASE  
LANZAMIENTO

## HIGH PRECISION DIGITAL SCALE BÁSCULA DIGITAL DE ALTA PRECISIÓN

Capacity / Capacidad: 3kg

Ref.	Un.	m <sup>3</sup>	7891116
61101/050*	04	0,009	170748



\* Imported Product / Producto Importado

Exclusive material for legal entities/corporate clients.  
Material exclusivo para clientes persona jurídica.



**DIGITAL KITCHEN SCALE  
WITH CUTTING BOARD  
BALANZA DIGITAL  
CON TABLA DE CORTAR PARA COCINA**

Capacity / Capacidad: 5kg

Ref.	Un.	m <sup>3</sup>	7891116
61101/010*	04	0,019	169254



**DIGITAL KITCHEN SCALE  
BALANZA DE COCINA DIGITAL**

Capacity / Capacidad: 5kg

Ref.	Un.	m <sup>3</sup>	7891116
61101/020*	04	0,009	169209



**FOLDABLE DIGITAL KITCHEN SCALE  
BALANZA DE COCINA DIGITAL PLEGABLE**

Capacity / Capacidad: 5kg

Ref.	Un.	m <sup>3</sup>	7891116
61101/030*	04	0,004	169216

Exclusive material for legal entities/corporate clients.  
Material exclusivo para clientes persona jurídica.





**ANALOG KITCHEN SCALE  
BALANZA DE COCINA ANALÓGICA**

Capacity / Capacidad: 5kg

Ref.	Un.	m <sup>3</sup>	7891116
61101/040*	04	0,048	169247



**NON-SLIP DIGITAL BATHROOM SCALE  
BALANZA CORPORAL DIGITAL  
ANTIDESLIZANTE**

Capacity / Capacidad: 150kg

Ref.	Un.	m <sup>3</sup>	7891116
61101/210*	04	0,019	169230



**DIGITAL BATHROOM SCALE  
BALANZA CORPORAL DIGITAL**

Capacity / Capacidad: 180kg

Ref.	Un.	m <sup>3</sup>	7891116
61101/220*	04	0,023	169223



**SMART DIGITAL BATHROOM SCALE  
BALANZA DIGITAL DE CUERPO SMART**

Capacity / Capacidad: 180kg

Ref.	Un.	m <sup>3</sup>	7891116
61101/230*	04	0,022	169193

\* Imported Product / Producto Importado





SALT AND PEPPER GRINDERS SET  
 JUEGO DE MOLINILLOS PARA SAL Y PIMIENTA  
 2 PC./PZAS

Ref.	Un.	m <sup>3</sup>	7891116
64650/000*	06	0,003	157848



SALT AND PEPPER GRINDER  
 MOLINILLO PARA SAL O PIMIENTA

Ref.	Un.	m <sup>3</sup>	7891116
61653/100*	04	0,005	157862



SALT AND PEPPER GRINDER  
 MOLINILLO PARA SAL O PIMIENTA

Ref.	Un.	m <sup>3</sup>	7891116
61654/100*	04	0,007	157855





SALT AND PEPPER GRINDER  
MOLINILLO PARA SAL O PIMIENTA

Ref.	Un.	m <sup>3</sup>	7891116
61652/000*	04	0,007	110812



SALT AND PEPPER GRINDER  
MOLINILLO PARA SAL O PIMIENTA

Ref.	Un.	m <sup>3</sup>	7891116
61653/000*	04	0,007	110829



SALT AND PEPPER GRINDER  
MOLINILLO PARA SAL Y PIMIENTA

Ref.	Un.	m <sup>3</sup>	7891116
61655/000*	04	0,005	126578





NEW RELEASE  
LANZAMIENTO

OIL OR VINEGAR CRUET  
DISPENSADOR PARA VINAGRE / ACEITE  
0,25L

Ref.	Un.	m <sup>3</sup>	7891116
61119/100*	04	-	170762



NEW RELEASE  
LANZAMIENTO

OIL OR VINEGAR CRUET  
DISPENSADOR PARA VINAGRE / ACEITE  
0,39L

Ref.	Un.	m <sup>3</sup>	7891116
61119/110*	04	-	170779

\* Imported Product / Producto Importado



Exclusive material for legal entities/corporate clients.  
Material exclusivo para clientes persona jurídica.



# UTILITY

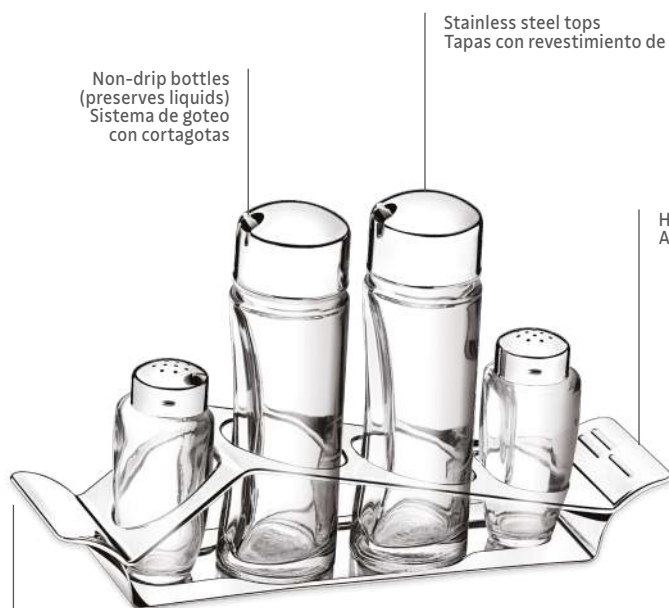

Non-drip bottles  
(preserves liquids)  
Sistema de goteo  
con cortagotas

Stainless steel tops  
Tapas con revestimiento de acero inoxidable

Handles on both sides for easier handling  
Asas en las dos extremidades que facilitan su manejo

**CRUET SET**  
JUEGO DE DISPENSADORES DE ACEITE / VINAGRE  
Y SAL/PIMIENTA  
5 PC./PZAS.

Ref.	Un.	m <sup>3</sup>	7891116
61533/010	04	0,023	075234

Rectangular caddy for easier table placement  
Formato rectangular que facilita el acondicionamiento en la mesa



**CRUET SET**  
JUEGO DE DISPENSADORES DE ACEITE / VINAGRE  
Y SAL/PIMIENTA  
5 PC./PZAS.

Ref.	Un.	m <sup>3</sup>	7891116
61119/000	04	0,031	023686



Exclusive material for legal entities/corporate clients.  
Material exclusivo para clientes persona jurídica.





SALT DISPENSER  
RECIPIENTE PARA SAL

	Ref.	Un.	m <sup>3</sup>	7891116
Ø 5cm	61130/050	08	0,004	034606



PEPPER DISPENSER  
RECIPIENTE PARA PIMIENTA

	Ref.	Un.	m <sup>3</sup>	7891116
Ø 5cm	61131/050	08	0,004	034613



CHEESE DISPENSER  
RECIPIENTE PARA QUESO

	Ref.	Un.	m <sup>3</sup>	7891116
Ø 8cm	61134/080	06	0,007	034620



SALT / PEPPER DISPENSER  
RECIPIENTE PARA SAL/PIMIENTA

	Ref.	Un.	m <sup>3</sup>	7891116
50g	61119/049	24	0,006	029374



TOOTHPICK HOLDER  
PALILLERO

	Ref.	Un.	m <sup>3</sup>	7891116
	61120/000	24	0,006	038666



OIL / VINEGAR CRUET  
DISPENSADOR DE ACEITE / VINAGRE

	Ref.	Un.	m <sup>3</sup>	7891116
0,17l	61119/059	24	0,017	029381



**TOOTHPICK HOLDER  
PALILLERO**

Ref.	Un.	m <sup>3</sup>	7891116
61105/000	12	0,009	001752



**TOOTHPICK HOLDER  
PALILLERO**

Ref.	Un.	m <sup>3</sup>	7891116
61105/005	24	0,012	053973

12 units per display box | Caja display con 12 unidades  
24 units per master box | Caja master con 24 unidades



**SALT / PEPPER DISPENSER  
RECIPIENTE PARA SAL / PIMIENTA**

Ref.	Un.	m <sup>3</sup>	7891116
61119/045	24	0,012	105870

12 units per display box | Caja display con 12 unidades  
24 units per master box | Caja master con 24 unidades



**TOOTHPICK HOLDER  
PALILLERO**

Ref.	Un.	m <sup>3</sup>	7891116
61120/005	24	0,012	105887

12 units per display box | Caja display con 12 unidades  
24 units per master box | Caja master con 24 unidades



SALT / PEPPER DISPENSER  
 RECIPIENTE PARA SAL / PIMIENTA

	Ref.	Un.	m <sup>3</sup>	7891116
50g	61119/042	12	0,009	106563



TOOTHPICK HOLDER  
 PALILLERO

	Ref.	Un.	m <sup>3</sup>	7891116
	61120/002	12	0,009	106570



TOOTHPICK HOLDER  
 PALILLERO

	Ref.	Un.	m <sup>3</sup>	7891116
	61105/002	12	0,007	106587



# NAPKIN HOLDERS PORTA SERVILLETAS



NAPKIN HOLDER  
PORTA SERVILLETAS  
QUADRATA

Ref.	Un.	m <sup>3</sup>	7891116
61782/110	10	0,010	105061



NAPKIN HOLDER  
PORTA SERVILLETAS  
CICLO

Ref.	Un.	m <sup>3</sup>	7891116
61522/000	12	0,014	061251



NAPKIN HOLDER  
PORTA SERVILLETAS  
CICLO

Ref.	Un.	m <sup>3</sup>	7891116
61532/000	12	0,049	075227



NAPKIN HOLDER  
PORTA SERVILLETAS  
COSMOS

Ref.	Un.	m <sup>3</sup>	7891116
61216/120	12	0,006	028179



NAPKIN HOLDER  
PORTA SERVILLETAS  
UTILITY

Ref.	Un.	m <sup>3</sup>	7891116
61284/120	12	0,006	013366



NAPKIN HOLDER  
PORTA SERVILLETAS  
UTILITY

Ref.	Un.	m <sup>3</sup>	7891116
61144/120	12	0,006	050231



**NAPKIN HOLDER  
PORTA SERVILLETAS**

Ref.	Un.	m <sup>3</sup>	7891116
61216/126	16	0,028	106556

8 units per display box | Caja display con 8 unidades  
16 units per master box | Caja master con 16 unidades



**UTENSIL HOLDER  
APOYO DE UTENSILIOS  
QUADRATA**

Ref.	Un.	m <sup>3</sup>	7891116
61781/120	10	0,003	105115

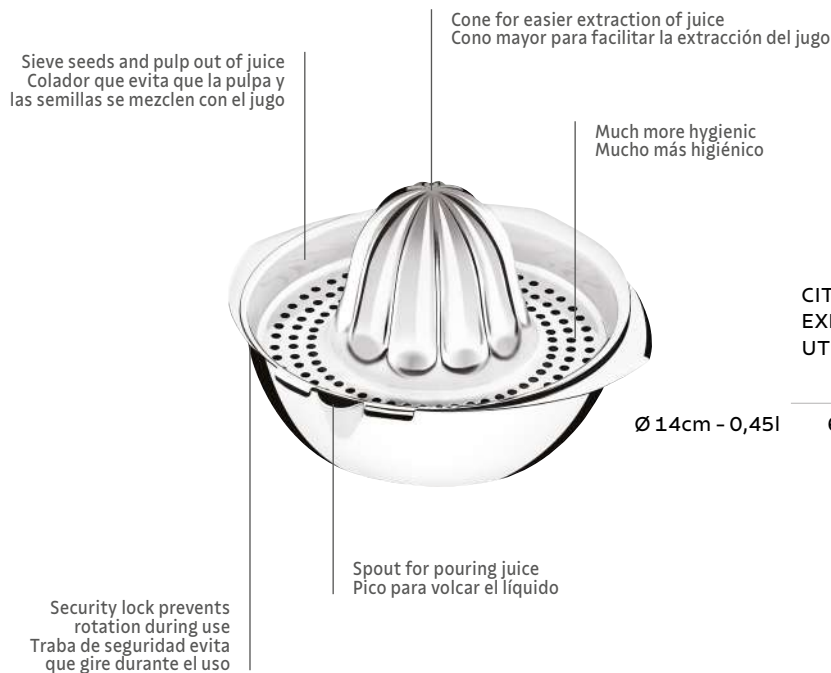

**CITRUS JUICER WITH BOWL  
EXPRIMIDOR DE FRUTAS  
UTILITY**

Ref.	Un.	m <sup>3</sup>	7891116
61107/140	10	0,031	071496

# UTILITY



SPAGHETTI TONG  
PINZA PARA PASTA  
208mm

	Ref.	Un.	m <sup>3</sup>	7891116
	63800/602	30	0,012	023488
	63800/605	12	0,006	036907



UTILITY TONG  
PINZA MULTIUSO  
206mm

	Ref.	Un.	m <sup>3</sup>	7891116
	63800/622	30	0,013	023365
	63800/625	12	0,006	105917



MULTIUSE TONG  
PINZA MULTIUSO  
182mm

	Ref.	Un.	m <sup>3</sup>	7891116
	63800/642	30	0,007	023495
	63800/645	12	0,006	036891



ICE TONG  
PINZA PARA HIELO  
180mm

	Ref.	Un.	m <sup>3</sup>	7891116
	63800/612	30	0,007	023358
	63800/615	12	0,006	106594



**BARBECUE TONG**  
**PINZA PARA ASADO**  
122mm

	Ref.	Un.	m <sup>3</sup>	7891116
	63800/682	30	0,003	043271
	63800/684	12	0,003	122587



**COLD CUTS TONG**  
**PINZA PARA FIAMBRES**  
205mm

	Ref.	Un.	m <sup>3</sup>	7891116
	63800/632	30	0,013	051740
	63800/635	12	0,006	106600



**ASPARGUS TONG**  
**PINZA PARA ESPÁRRAGOS**  
228mm

	Ref.	Un.	m <sup>3</sup>	7891116
	63800/650	10	0,014	020753
	63800/652	20	0,023	030110



--0  
**GIFT BOX**  
**ESTUCHE DE REGALO**



--2  
**PLASTIC BAG**  
**BOLSA PLÁSTICA**



--4/5  
**PACKAGED IN RETAIL, HANG-TAG**  
**BLISTER DE AUTOSERVICIO**





**MULTIUSE TONG  
PINZA MULTIUSO  
290mm**

Ref.	Un.	m <sup>3</sup>	7891116
63800/700	12	0,023	051955
63800/702	12	0,007	051986



**SPAGHETTI TONG  
PINZA PARA PASTA  
280mm**

Ref.	Un.	m <sup>3</sup>	7891116
63800/802	12	0,006	066102
63800/805	12	0,007	105924



**PIZZA TONG  
PINZA PARA PIZZA  
283mm**

Ref.	Un.	m <sup>3</sup>	7891116
63800/862	12	0,007	148556
63800/865	12	0,007	148563



**MULTIUSE TONG  
PINZA MULTIUSO  
280mm**

Ref.	Un.	m <sup>3</sup>	7891116
63800/842	12	0,007	103715
63800/845	12	0,007	105931



**CHEESE SLICER  
CORTADOR DE QUESO  
213mm**

Ref.	Un.	m <sup>3</sup>	7891116
63950/510	30	0,013	004098



**SALAD SERVERS  
JUEGO DE CUBIERTOS  
PARA ENSALADA  
2 PC./PZAS.**

Ref.	Un.	m <sup>3</sup>	7891116
66999/600	20	0,031	000205

Contents / Contenido:  
1 Salad Spoon / Cuchara para Ensalada  
1 Salad Fork / Tenedor para Ensalada



**SPAGHETTI TONG  
PINZA PARA PASTA**

	Ref.	Un.	m <sup>3</sup>	7891116
208mm	63800/604	24	0,026	108154

12 units per display box | Caja display con 12 unidades  
24 units per master box | Caja master con 24 unidades



**UTILITY TONG  
PINZA MULTIUSO**

	Ref.	Un.	m <sup>3</sup>	7891116
206mm	63800/624	24	0,026	108161

12 units per display box | Caja display con 12 unidades  
24 units per master box | Caja master con 24 unidades



**TONGS UNIQUE PRICE  
PRECIO ÚNICO DE PINZAS  
64 PC./PZAS.**

	Ref.	Un.	m <sup>3</sup>	7891116
	66800/110*	64	0,026	149485

\*Price per unit / Precio por unidad

Contents / Contenido:  
20 Spaghetti Tong / Pinza para Pasta 208mm  
08 Ice Tong / Pinza para Hielo 180mm  
12 Multiuse Tong / Pinza Multiuso 206mm  
08 Multiuse Tong / Pinza Multiuso 182mm  
10 Spaghetti Tong / Pinza para Pasta 280mm  
06 Barbecue Tong / Pinza para Asado 122mm



These three products have a hook so they can be attached to pots or serving trays.  
Esos tres productos tienen una garra para fijarse a las ollas o fuentes.

**SOUP LADLE  
CAZO PARA SOPA  
303mm**

Ref.	Un.	m <sup>2</sup>	7891116
63814/090	48	0,031	045329

**SERVING SPOON  
CUCHARA PARA SERVIR  
302mm**

Ref.	Un.	m <sup>2</sup>	7891116
63814/100	48	0,015	045336

**CARVING FORK  
TENEDOR TRINCHANTE  
310mm**

Ref.	Un.	m <sup>2</sup>	7891116
63814/470	48	0,015	045343



**SALAD SPOON  
CUCHARA PARA ENSALADA  
302mm**

Ref.	Un.	m <sup>2</sup>	7891116
63812/321	12	0,005	026113
63812/322	48	0,015	053577







SERVING SPOON  
CUCHARA PARA SERVIR  
302mm

Ref.	Un.	m <sup>3</sup>	7891116
63812/101	12	0,005	026090
63812/102	48	0,015	053553



SOUP LADLE  
CAZO PARA SOPA  
300mm

Ref.	Un.	m <sup>3</sup>	7891116
63812/091	12	0,005	026083
63812/092	48	0,031	053546



SKIMMER  
ESPUMADERA  
334mm

Ref.	Un.	m <sup>3</sup>	7891116
63812/221	12	0,005	026106
63812/222	48	0,022	053560



SLOTTED TURNER  
ESPÁTULA PARA FRITURA  
330mm

Ref.	Un.	m <sup>3</sup>	7891116
63812/391	12	0,005	026120
63812/392	48	0,015	053584



CARVING FORK  
TENEDOR TRINCHANTE  
308mm

Ref.	Un.	m <sup>3</sup>	7891116
63812/471	12	0,005	026137
63812/472	48	0,015	053591



POTATO MASHER  
PRENSA PAPAS  
265mm

Ref.	Un.	m <sup>3</sup>	7891116
63812/491	12	0,005	026144
63812/492	48	0,022	053607



SPAGHETTI SPOON  
CUCHARA PARA PASTA  
298mm

Ref.	Un.	m <sup>3</sup>	7891116
63812/501	12	0,005	026151
63812/502	48	0,015	053614

--1  
PACKAGED IN RETAIL HANG-TAG  
BLISTER DE AUTOSERVICIO

--2  
PLASTIC BAG  
BOLSA PLÁSTICA



SPATULA  
ESPÁTULA  
295mm

Ref.	Un.	m <sup>3</sup>	7891116
63809/920*	12	0,005	168776



CAN / BOTTLE OPENER  
ABRIDOR DE BOTELLAS CON ABRELATAS  
203mm

Ref.	Un.	m <sup>3</sup>	7891116
63809/900*	12	0,010	157886



ICE CREAM SCOOP WITH TRIGGER  
CUCHARA DE HELADO CON EXTRACTOR  
215mm

Ref.	Un.	m <sup>3</sup>	7891116
63809/420*	12	0,015	157893



ICE CREAM SCOOP  
CUCHARA DE HELADO  
210mm

Ref.	Un.	m <sup>3</sup>	7891116
63809/410*	12	0,007	157909



BOTTLE/CAN OPENER  
ABRIDOR DE BOTELLAS CON ABRELATAS  
182mm

Ref.	Un.	m <sup>3</sup>	7891116
63809/910*	12	0,005	157916

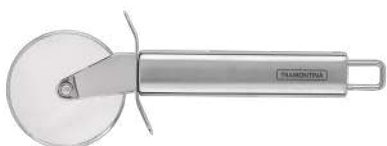

PIZZA CUTTER WHEEL  
CORTADOR DE PIZZA  
192mm

Ref.	Un.	m <sup>3</sup>	7891116
63809/130*	12	0,007	157923



VEGETABLE PEELER  
PELADOR DE LEGUMBRES  
182mm

Ref.	Un.	m <sup>3</sup>	7891116
63809/440*	12	0,005	157930







Exclusive material for legal entities/corporate clients.  
Material exclusivo para clientes persona jurídica.



POTATO PEELER  
PELADOR DE PAPAS  
194mm

Ref.	Un.	m <sup>3</sup>	7891116
63809/560*	12	0,010	157947



CAKE SERVER  
ESPÁTULA PARA PASTEL  
272mm

Ref.	Un.	m <sup>3</sup>	7891116
63809/150*	12	0,007	157954



CHEESE SLICER  
CORTADOR DE QUESOS  
237mm

Ref.	Un.	m <sup>3</sup>	7891116
63809/510*	12	0,007	157961



SPATULA  
ESPÁTULA  
346mm

Ref.	Un.	m <sup>3</sup>	7891116
63809/230*	12	0,009	157978



SERVING SPOON  
CUCHARA PARA SERVIR  
326mm

Ref.	Un.	m <sup>3</sup>	7891116
63809/100*	12	0,009	157985



SKIMMER  
ESPUMADERA  
365mm

Ref.	Un.	m <sup>3</sup>	7891116
63809/220*	12	0,018	157992



LADLE  
CAZO  
330mm

Ref.	Un.	m <sup>3</sup>	7891116
63809/090*	12	0,009	158005



SPAGHETTI SPOON  
CUCHARA PARA PASTA  
345mm

Ref.	Un.	m <sup>3</sup>	7891116
63809/500*	12	0,009	158012

\* Imported Product / Producto Importado

Exclusive material for legal entities/corporate clients.  
Material exclusivo para clientes persona jurídica.





POTATO MASHER  
PRENSA PAPAS  
294mm

Ref.	Un.	m <sup>3</sup>	7891116
63809/490*	12	0,007	158029



STRAINER  
COLADOR  
330mm - Ø 15,3cm

Ref.	Un.	m <sup>3</sup>	7891116
63809/590*	12	0,007	158050



SILICONE SPATULA  
ESPÁTULA DE SILICONA  
311mm

Ref.	Un.	m <sup>3</sup>	7891116
63809/400*	12	0,006	158036



WHISK  
BATIDOR  
290mm

Ref.	Un.	m <sup>3</sup>	7891116
63809/520*	12	0,009	158043



WHISK  
BATIDOR  
324mm

Ref.	Un.	m <sup>3</sup>	7891116
63809/530*	12	0,023	158067



WHISK  
BATIDOR  
374mm

Ref.	Un.	m <sup>3</sup>	7891116
63809/540*	12	0,023	158074



WHISK  
BATIDOR  
424mm

Ref.	Un.	m <sup>3</sup>	7891116
63809/550*	12	0,023	160114





# EXTRATA

SPAGHETTI SPOON  
CUCHARA PARA PASTA  
316mm

Ref.	Un.	m <sup>3</sup>	7891116
63815/501	12	0,003	168905
63815/502	12	0,003	168912



CARVING FORK  
TENEDOR TRINCHANTE  
311mm

Ref.	Un.	m <sup>3</sup>	7891116
63815/471	12	0,002	115640
63815/472	12	0,002	116890



SERVING SPOON  
CUCHARA PARA SERVIR  
310mm

Ref.	Un.	m <sup>3</sup>	7891116
63815/101	12	0,002	115626
63815/102	12	0,002	116876



SLOTTED SERVING SPOON  
CUCHARA PARA SERVIR PERFORADA  
310mm

Ref.	Un.	m <sup>3</sup>	7891116
63815/321	12	0,002	115664
63815/322	12	0,002	116913



LADLE  
CAZO  
309mm

Ref.	Un.	m <sup>3</sup>	7891116
63815/091	12	0,005	115657
63815/092	12	0,005	116906



SKIMMER  
ESPUMADERA  
314mm

Ref.	Un.	m <sup>3</sup>	7891116
63815/221	12	0,005	115671
63815/222	12	0,005	116920



SLOTTED TURNER  
ESPÁTULA  
312mm

Ref.	Un.	m <sup>3</sup>	7891116
63815/391	12	0,002	115633
63815/392	12	0,002	116883

--1  
PACKAGED IN RETAIL HANG-TAG  
BLISTER DE AUTOSERVICIO

--2  
PLASTIC BAG  
BOLSA PLÁSTICA

# SETS AND DISPLAYS

# JUEGOS Y DISPLAYS



KITCHEN UTENSILS SET  
JUEGO DE UTENSILIOS  
3 PC./PZAS.  
EXTRATA

Ref.	Un.	m <sup>3</sup>	7891116
66815/730	12	0,023	123355

Contents / Contenido:  
1 Ladle / Cazo  
1 Slotted Spatula / Espátula Perforada  
1 Serving Spoon / Cuchara para Servir



KITCHEN UTENSILS SET  
JUEGO DE UTENSILIOS  
4 PC./PZAS.  
EXTRATA

Ref.	Un.	m <sup>3</sup>	7891116
66815/710	04	0,037	117538

Contents / Contenido:  
1 Ladle / Cazo  
1 Slotted Spatula / Espátula Perforada  
1 Serving Spoon / Cuchara para Servir  
1 Carving Fork/ Tenedor Trinchante



KITCHEN UTENSILS SET  
JUEGO DE UTENSILIOS  
5 PC./PZAS.  
EXTRATA

Ref.	Un.	m <sup>3</sup>	7891116
66815/700	05	0,075	117521

Contents / Contenido:  
1 Serving Spoon / Cuchara para Servir  
1 Slotted Spatula / Espátula Perforada  
1 Carving Fork / Tenedor Trinchante  
1 Ladle / Cazo  
1 Skimmer/ Espumadera

Additional accessories / Accesorios adicionales:  
1 Stainless Steel Rack / 1 Soporte de Acero Inoxidable



KITCHEN UTENSILS SET  
JUEGO DE UTENSILIOS  
5 PC./PZAS.  
UTILITY

Ref.	Un.	m <sup>3</sup>	7891116
66812/700	05	0,071	025550

Contents / Contenido:  
1 Soup Ladle / Cazo para Sopa  
1 Serving Spoon / Cuchara para Servir  
1 Carving Fork / Tenedor Trinchante  
1 Skimmer / Espumadera  
1 Slotted Turner / Espátula para Fritura

Additional accessories / Accesorios adicionales:  
1 Stainless Steel Rack / 1 Soporte de Acero Inoxidable



**KITCHEN UTENSILS SET**  
**JUEGO DE UTENSILIOS**  
**6 PC./PZAS.**  
**UTILITY**

Ref.	Un.	m <sup>3</sup>	7891116
66800/103	08	0,045	146996

Contents / Contenido:  
 1 Barbecue Tong / Pinza para Asado 122mm  
 1 Ice Tong / Pinza para Hielo 180mm  
 1 Spaghetti Tong / Pinza para Pasta 280mm  
 1 Utility Tong / Pinza Multiuso 280mm  
 1 Multiuse Tong / Pinza Multiuso 206mm  
 1 Spaghetti Tong / Pinza para Pasta 208mm



**KITCHEN UTENSILS SET**  
**JUEGO DE UTENSILIOS**  
**5 PC./PZAS.**  
**UTILITY**

Ref.	Un.	m <sup>3</sup>	7891116
66906/720	06	0,045	081112

Contents / Contenido:  
 1 Serving Spoon / Cuchara para Servir  
 1 Spaghetti Tong / Pinza para Pasta  
 1 Cake Server / Espátula para Pastel  
 1 Carving Fork / Tenedor Trinchante  
 1 Ladle / Cazo Mediano



**KITCHEN UTENSILS SET**  
**JUEGO DE UTENSILIOS**  
**4 PC./PZAS.**  
**HAVANA**

Ref.	Un.	m <sup>3</sup>	7891116
66945/710	06	0,045	149492

Contents / Contenido:  
 1 Serving Spoon / Cuchara para Servir  
 1 Carving Fork / Tenedor Trinchante  
 1 Ladle / Cazo Mediano  
 1 Spaghetti Tong / Pinza para Pasta



**UTENSILS UNIQUE PRICE**  
**PRECIO ÚNICO DE UTENSILIOS**  
**54 PC./PZAS.**

Ref.	Un.	m <sup>3</sup>	7891116
66945/750*	54	0,007	149508

\*Price per unit / Precio por unidad

Contents / Contenido:  
 24 Serving Spoon / Cuchara para Servir  
 10 Cake Server / Espátula para Pastel  
 10 Ladle / Cazo Mediano  
 10 Carving Fork / Tenedor trinchant



		Ref.	Un.	m <sup>3</sup>	7891116
200g	60900/010	12	0,004	059593	



		Ref.	Un.	m <sup>3</sup>	7891116
200g	60900/000	12	0,006	032831	



		Ref.	Un.	m <sup>3</sup>	7891116
300ml	60900/050	12	0,012	071229	



		Ref.	Un.	m <sup>3</sup>	7891116
	60900/020	12	0,024	069042	

12 Units per display box / Caja display con 12 unidades



# OVEN AND STOVE

# COCINA Y HORNO

---



Exclusive material for legal entities/corporate clients.  
Material exclusivo para clientes persona jurídica.

## PERFORMANCE AND DURABILITY

# THE PROTAGONISTS OF YOUR KITCHEN

A show of versatility, technology and resistance Tramontina's Oven and Stove line offers a complete range of cookware and accessories that highlight the flavor of preparing and experimenting with the best recipes.

Everything with the reliability and resistance of stainless steel, which ensures more efficient cooking without releasing any particles into the food.

## DESEMPEÑO Y DURABILIDAD

# LOS PROTAGONISTAS DE LA COCINA

Un show de versatilidad, tecnología y resistencia. La línea Horno y Cocina de Tramontina trae una familia completa de ollas y accesorios que realzan el sabor de preparar y probar las mejores recetas.

Todo con la confiabilidad y la resistencia del acero inoxidable, que garantiza una cocción más eficiente sin dejar residuos en los alimentos.



## **DISTINGUISHING FEATURES OF TRAMONTINA'S STAINLESS STEEL COOKWARE:**

## **DIFERENCIALES DE LAS OLLAS DE ACERO INOXIDABLE TRAMONTINA:**

### **DISHWASHER SAFE RESISTEN AL LAVAVAJILLAS**

Convenient and resistant, the cookware is dishwasher safe and won't lose its quality or shine.

Practicidad y resistencia para ir al lavavajillas sin perder la calidad o el brillo.

### **OVEN SAFE SE PUEDEN LLEVAR AL HORNO**

The 100% stainless steel models can go in the oven to finish dishes.

Los modelos 100% en acero inoxidable se pueden usar dentro del horno en la finalización de platos.



### **WITH TRI-PLY BASE TIENEN FONDO TRIPLE**

There are three layers: stainless steel, aluminum and stainless steel again. Guaranteed resistance and superior performance.

Una capa de acero inoxidable, una de aluminio y otra de acero inoxidable. Garantía de resistencia y desempeño superior.

### **WITH STEAM VENT TIENEN SALIDA DE VAPOR**

Located on the lid, the steam vent ensures total safety when cooking.

Ubicada en la tapa, la salida de vapor garantiza total seguridad en la cocción.

### **COMPATIBLE WITH ALL STOVES COMPATIBLES CON TODAS LAS COCINAS**

The cookware can be used on all types of stovetops: gas, glass-ceramic, electric and induction.

Pueden usarse en todos los tipos de cocina - a gas, vitrocerámica, eléctrica y de inducción.





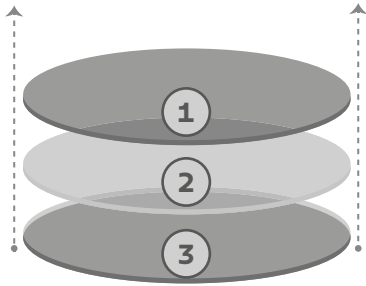

LAYER 1

## STAINLESS STEEL ACERO INOXIDABLE

Layer in direct contact with foods. No loose particles and it is hygienic.

Capa que entra en contacto con el alimento. No suelta partículas y es higiénico.

LAYER 2

## ALUMINUM ALUMÍNIO

Excellent heat conductor. Keeps uniform temperature distribution.

Excelente conductor de calor, mantiene la temperatura uniforme.

LAYER 3

## STAINLESS STEEL ACERO INOXIDABLE

An extra stainless steel layer in the exterior makes it more resistant and durable.

En la parte externa, una capa más de acero inoxidable. Eso garantiza resistencia y durabilidad.

Exclusive material for legal entities/corporate clients.  
Material exclusivo para clientes persona jurídica.

## TRUE TRI-PLY BASE EL VERDADERO FONDO TRIPLE

Stainless steel, aluminum and stainless steel. This is how Tramontina ensures its cookware will save your money and keep your food warm for longer. The interior stainless steel layer comes into contact with food without releasing any particles. The middle aluminum layer distributes heat for more efficient cooking. The exterior stainless steel layer ensures durability for use on all types of stovetops.

Acero inoxidable, aluminio y acero inoxidable. Es así que Tramontina garantiza economía y comida caliente por más tiempo en todas sus ollas. La capa interna de acero inoxidable queda en contacto con los alimentos y no suelta residuos. En el medio, el aluminio distribuye el calor para hacer que la cocción más eficiente. El acero inoxidable de la parte externa garantiza la durabilidad para el uso en todos los tipos de cocina.







## GRANO • 70

**MATERIALS** Tri-ply stainless steel, polished finish, stainless steel handles.

**MATERIALES** Acero inoxidable con cuerpo triple, terminación pulida, mangos y asas de acero inoxidable.

**ADVANTAGES** Temperature and performance balance as well as oven safe.

**VENTAJAS** Equilibrio en la temperatura y desempeño y se puede llevar al horno.



## GRANO BAKELITE GRANO BAQUELITA

• 76

**MATERIALS** Tri-ply stainless steel, polished finish, bakelite handles.

**MATERIALES** Acero inoxidable con cuerpo triple, terminación pulida, mangos y asas de baquelita.

**ADVANTAGES** Temperature and performance balance.

**VENTAJAS** Equilibrio en la temperatura y en el desempeño.



## GRANO COMPACT

• 80

**MATERIALS** Tri-ply stainless steel, polished finish, silicone handles.

**MATERIALES** Acero inoxidable con cuerpo triple, terminación pulida, mangos y asas de silicona.

**ADVANTAGES** Temperature and performance balance.

**VENTAJAS** Equilibrio en la temperatura y desempeño.



## DUO SILICONE • 83

**MATERIALS** Tri-ply base stainless steel cookware with polished finish and heat-resistant silicone handles.

**MATERIALES** Acero inoxidable con fondo triple, terminación pulida, mangos y asas de silicona antitérmica.

**ADVANTAGES** Heat-resistant handles and knobs. Tightly sealed lid with secure fit.

**VENTAJAS** Los mangos y las asas no se calientan durante la cocción. Tapa con cierre interno y sellado perfecto.



## PROFESSIONAL • 88

**MATERIALS** Tri-ply base stainless steel cookware with polished finish and stainless steel handles.

**MATERIALES** Acero inoxidable con fondo triple, terminación pulida, mangos y asas de acero inoxidable.

**ADVANTAGES** Long tubular handles for professional handling. Handles spot-welded (more durable). Perfect sealing lid.

**VENTAJAS** Asas largas y mangos tubulares para manejo profesional. Mangos y asas fijados con soldadura a punto (mayor esfuerzo). Sellado perfecto de la tapa.



## SOLAR • 98

**MATERIALS** Tri-ply base stainless steel cookware with polished finish and stainless steel handles.

**MATERIALES** Acero inoxidable con fondo triple, terminación pulida, mangos y asas de acero inoxidable.

**ADVANTAGES** A Tramontina classic, the Solar cookware is resistant and efficient.

**VENTAJAS** Un clásico de Tramontina, la olla Solar es resistente y eficiente.



## SOLAR BAKELITE SOLAR BAQUELITA • 106

**MATERIALS** Tri-ply base stainless steel cookware with polished finish and heat-resistant bakelite handles.

**MATERIALES** Acero inoxidable con fondo triple, terminación pulida, mangos y asas de baquelita antitérmica.

**ADVANTAGES** Heat-resistant handles and knobs.

**VENTAJAS** Los mangos y asas no se calientan durante la cocción.



## SOLAR CERAMIC • 110

**MATERIALS** Tri-ply base stainless steel cookware and internal ceramic coating. Tempered glass lid with silicone rim and knob.

**MATERIALES** Acero inoxidable con fondo triple y revestimiento interno de cerámica. Tapa de vidrio templado con bordes y pomo de silicona.

**ADVANTAGES** Ceramic lining. Handles knobs are coated in heatproof silicone to prevent burns and provide a softer, more comfortable grip.

**VENTAJAS** Revestimiento de cerámica. Las asas, mangos y pomos vienen con revestimiento de silicona antitérmica, que evita quemaduras y hace que el agarre sea más suave y cómodo.



## UNA • 120

**MATERIALS** Tri-ply base stainless steel cookware with polished finish and stainless steel handles.

**MATERIALES** Acero inoxidable con fondo triple terminación pulida, mangos y asas de acero inoxidable.

**ADVANTAGES** Welded stainless steel handles, safer and more resistant. Tempered glass lid with steam vent allows you to view the food while cooking.

**VENTAJAS** Mangos y asas de acero inoxidable soldados, más resistentes y seguros. Tapa de vidrio templado con salida de vapor, que permite visualizar los alimentos durante la cocción.



## SOLAR SILICONE • 112

**MATERIALS** Tri-ply base stainless steel cookware. Tempered glass lid with silicone rim and knob.

**MATERIALES** Acero inoxidable con fondo triple. Tapa de vidrio templado con bordes y pomo de silicona.

**ADVANTAGES** Handles knobs are coated in heatproof silicone to prevent burns and provide a softer, more comfortable grip.

**VENTAJAS** Las asas, mangos y pomos vienen con revestimiento de silicona antitérmica, que evita quemaduras y hace que el agarre sea más suave y cómodo.



## UNA CERAMIC • 124

**MATERIALS** Tri-ply base stainless steel cookware with polished finish and stainless steel handles and internal ceramic coating.

**MATERIALES** Acero inoxidable con fondo triple terminación pulida, mangos y asas de acero inoxidable y revestimiento interno de cerámica.

**ADVANTAGES** Welded stainless steel handles, safer and more resistant. Tempered glass lid with steam vent allows you to view the food while cooking.

**VENTAJAS** Mangos y asas de acero inoxidable soldados, más resistentes y seguros. Tapa de vidrio templado con salida de vapor, que permite visualizar los alimentos durante la cocción.



## BRAVA BAKELITE BRAVA BAQUELITA • 127

**MATERIALS** Tri-ply base stainless steel cookware with polished finish and heat-resistant bakelite handles.

**MATERIALES** Acero inoxidable con fondo triple, terminación pulida, mangos y asas de baquelita antitérmica.

**ADVANTAGES** Heat-resistant handles and knobs.

**VENTAJAS** Los mangos y asas no se calientan durante la cocción.



## BRAVA NON-STICK BRAVA ANTIADHERENTE • 129

**MATERIALS** Tri-ply base stainless steel cookware with polished finish and heat-resistant bakelite handles.

**MATERIALES** Acero inoxidable con fondo triple, terminación pulida, mangos y asas de baquelita antitérmica.

**ADVANTAGES** Heat-resistant handles and knobs and internal non-stick finish. Ease of cleaning and free of PFOA.

**VENTAJAS** Los mangos y asas no se calientan durante la cocción y el acabado interno antiadherente. Facilidad de limpieza y libre de PFOA.



## BRAVA • 131

**MATERIALS** Tri-ply base stainless steel cookware with polished finish and stainless steel handles.

**MATERIALES** Acero inoxidable con fondo triple, terminación pulida, mangos y asas de acero inoxidable.

**ADVANTAGES** Clean and modern. Straight wall, easy to clean.

**VENTAJAS** Diseño liviano y moderno. Parede recta, fácil de limpiar.



## ALLEGRA • 135

**MATERIALS** Tri-ply base stainless steel cookware with polished finish and stainless steel handles.

**MATERIALES** Acero inoxidable con fondo triple, terminación pulida, mangos y asas de acero inoxidable.

**ADVANTAGES** Excellent value and clean design. Also available with glass lid.

**VENTAJAS** Excelente costo beneficio y diseño simple. Disponible también con tapa de vidrio.



# Grano



TecnoHeat



The Grano cookware brings the Tecnoheat technology to your kitchen, with a clean design and tri-ply for better performance and faster cooking. It also lets you finish your dishes in the oven. A wonder of versatility.

Las ollas Grano llegan a la cocina con la tecnología Tecnoheat, con diseño simple y cuerpo con triple capa, que mejora el desempeño y la velocidad de cocción y además permite finalizar la preparación dentro del horno. Un show de versatilidad.



**TecnoHeat**

Temperature and performance balance as well as fast cooking.

Equilibrio en la temperatura y desempeño y velocidad en la cocción.



SAUCE PAN  
OLLA

	Ref.	Un.	m <sup>3</sup>	7891116
Ø 16cm - 1,70l	62141/160	04	0,053	158999
Ø 20cm - 3,10l	62141/200	04	0,077	170397



CASSEROLE  
CACEROLA

	Ref.	Un.	m <sup>3</sup>	7891116
Ø 24cm - 4,70l	62143/240	04	0,070	159019



DEEP CASSEROLE  
CACEROLA HONDA

	Ref.	Un.	m <sup>3</sup>	7891116
Ø 20cm - 3,80l	62144/200	04	0,054	159002
Ø 24cm - 5,80l	62144/240	04	0,067	159026



STOCK POT  
OLLA ALTA

	Ref.	Un.	m <sup>3</sup>	7891116
Ø 24cm - 7,70l	62145/240	04	0,101	159033



WOK

	Ref.	Un.	m <sup>3</sup>	7891116
Ø 32cm - 5,20l	62158/320	02	0,099	158968

Non-stick Coating  
Revestimiento Antiadherente



WOK

	Ref.	Un.	m <sup>3</sup>	7891116
Ø 32cm - 5,20l	62158/327	02	0,099	160015



SAUTE PAN  
SARTÉN

	Ref.	Un.	m <sup>3</sup>	7891116
Ø 30cm - 5,60l	62140/300	02	0,082	158975



SKILLET  
PLANCHA

	Ref.	Un.	m <sup>3</sup>	7891116
22x22cm - 1,20l	62159/220	04	0,046	169100
26x26cm - 1,90l	62159/280	04	0,046	159088

Non-stick Coating  
Revestimiento Antiadherente



SKILLET  
PLANCHA

	Ref.	Un.	m <sup>3</sup>	7891116
22x22cm - 1,20l	62159/227	04	0,046	169117
26x26cm - 1,90l	62159/287	04	0,046	159798



NEW RELEASE  
LANZAMIENTO

SQUARE POT  
OLLA CUADRADA

	Ref.	Un.	m <sup>3</sup>	7891116
22x22cm - 4,00l	62144/220	04	0,071	169131
26x26cm - 7,30l	62144/260	04	0,099	158982



FRYING PAN  
SARTÉN

	Ref.	Un.	m <sup>3</sup>	7891116
Ø 20cm - 1,20l	62155/200	04	0,025	159040
Ø 26cm - 2,20l	62155/260	04	0,046	159057
Ø 30cm - 3,40l	62155/300	04	0,061	159064



Exclusive material for legal entities/corporate clients.  
Material exclusivo para clientes persona jurídica.



Non-stick Coating  
Revestimiento Antiadherente



**FRYING PAN  
SARTÉN**

	Ref.	Un.	m <sup>3</sup>	7891116
Ø 20cm - 1,20l	62155/207	04	0,025	159583
Ø 26cm - 2,20l	62155/267	04	0,046	159590
Ø 30cm - 3,40l	62155/307	04	0,061	159606



**FRYING PAN SET  
JUEGO DE SARTENES  
2 PC./PZAS.**

	Ref.	Un.	m <sup>3</sup>	7891116
	65140/306	02	0,048	165645

Contents / Contenido:  
1 Frying pan / Sartén Ø 20cm - 1,20l  
1 Frying pan / Sartén Ø 26cm - 2,20l



**FRYING PAN SET  
JUEGO DE SARTENES  
2 PC./PZAS.**

	Ref.	Un.	m <sup>3</sup>	7891116
	65140/316	02	0,048	165652

Contents / Contenido:  
1 Frying pan / Sartén Ø 26cm - 2,20l  
1 Frying pan / Sartén Ø 30cm - 3,40l



**FRYING PAN SET  
JUEGO DE SARTENES  
2 PC./PZAS.**

	Ref.	Un.	m <sup>3</sup>	7891116
	65140/326	02	0,048	165669

Contents / Contenido:  
1 Frying pan / Sartén Ø 20cm - 1,20l  
1 Frying pan / Sartén Ø 30cm - 3,40l



**FRYING PAN SET  
JUEGO DE SARTENES  
3 PC./PZAS.**

	Ref.	Un.	m <sup>3</sup>	7891116
	65140/336	02	0,056	165676

Contents / Contenido:  
1 Frying pan / Sartén Ø 20cm - 1,20l  
1 Frying pan / Sartén Ø 26cm - 2,20l  
1 Frying pan / Sartén Ø 30cm - 3,40l

Non-stick Coating  
Revestimiento Antiadherente

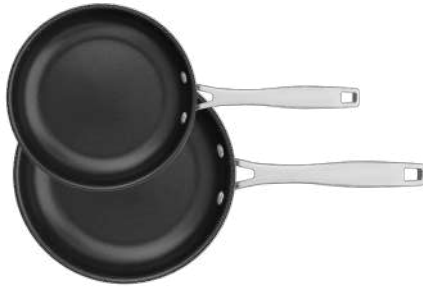

FRYING PAN SET  
JUEGO DE SARTENES  
2 PC./PZAS.

Ref.	Un.	m <sup>3</sup>	7891116
65140/307	02	0,048	165683

Contents / Contenido:  
1 Frying pan / Sartén Ø 20cm - 1,20l  
1 Frying pan / Sartén Ø 26cm - 2,20l

Non-stick Coating  
Revestimiento Antiadherente



FRYING PAN SET  
JUEGO DE SARTENES  
2 PC./PZAS.

Ref.	Un.	m <sup>3</sup>	7891116
65140/317	02	0,048	165690

Contents / Contenido:  
1 Frying pan / Sartén Ø 26cm - 2,20l  
1 Frying pan / Sartén Ø 30cm - 3,40l

Non-stick Coating  
Revestimiento Antiadherente



FRYING PAN SET  
JUEGO DE SARTENES  
2 PC./PZAS.

Ref.	Un.	m <sup>3</sup>	7891116
65140/327	02	0,053	165706

Contents / Contenido:  
1 Frying pan / Sartén Ø 20cm - 1,20l  
1 Frying pan / Sartén Ø 30cm - 3,40l

Non-stick Coating  
Revestimiento Antiadherente



FRYING PAN SET  
JUEGO DE SARTENES  
3 PC./PZAS.

Ref.	Un.	m <sup>3</sup>	7891116
65140/337	02	0,060	165713

Contents / Contenido:  
1 Frying pan / Sartén Ø 20cm - 1,20l  
1 Frying pan / Sartén Ø 26cm - 2,20l  
1 Frying pan / Sartén Ø 30cm - 3,40l



COOKWARE SET  
BATERÍA DE COCINA  
4 PC./PZAS.

Ref.	Un.	m <sup>3</sup>	7891116
65140/000	02	0,081	161227

Contents / Contenido:  
1 Sauce Pan / Olla Ø 16cm - 1,70l  
1 Casserole / Cacerola Ø 24cm - 4,40l  
1 Deep Casserole / Cacerola Honda Ø 20cm - 3,50l  
1 Frying Pan / Sartén Ø 26cm - 2,20l

# Grano Bakelite baquelita



TecnoHeat



The elegance of the Grano cookware combined with the safety and comfort of Bakelite handles. Exclusive technology that ensures an even more enjoyable experience while cooking.

La elegancia de las ollas Grano con la seguridad y comodidad de los mangos de baquelita. Tecnologías exclusivas que garantizan una experiencia todavía más placentera ante el horno o la cocina.



**TecnoHeat**

Temperature and performance balance as well as fast cooking.

Equilibrio en la temperatura y desempeño y velocidad en la cocción.



SAUCE PAN  
OLLA

	Ref.	Un.	m <sup>3</sup>	7891116
Ø 16cm - 1,70l	62161/160	04	0,036	159071
Ø 20cm - 3,10l	62161/200	04	0,056	170342



CASSEROLE  
CACEROLA

	Ref.	Un.	m <sup>3</sup>	7891116
Ø 24cm - 4,70l	62163/240	04	0,077	159101



DEEP CASSEROLE  
CACEROLA HONDA

	Ref.	Un.	m <sup>3</sup>	7891116
Ø 20cm - 3,80l	62164/200	04	0,054	159095
Ø 24cm - 5,80l	62164/240	04	0,092	159118



STOCK POT  
OLLA ALTA

	Ref.	Un.	m <sup>3</sup>	7891116
Ø 24cm - 7,70l	62165/240	04	0,108	159125





**FRYING PAN  
SARTÉN**

	Ref.	Un.	m <sup>3</sup>	7891116
Ø 20cm - 1,20l	62175/200	04	0,025	159132
Ø 26cm - 2,20l	62175/260	04	0,046	159149
Ø 30cm - 3,40l	62175/300	04	0,061	159156

Non-stick Coating  
Revestimiento Antiadherente



**FRYING PAN  
SARTÉN**

	Ref.	Un.	m <sup>3</sup>	7891116
Ø 20cm - 1,20l	62175/207	04	0,025	159613
Ø 26cm - 2,20l	62175/267	04	0,046	159620
Ø 30cm - 3,40l	62175/307	04	0,061	159637



**COOKWARE SET  
BATERÍA DE COCINA  
4 PC./PZAS.**

	Ref.	Un.	m <sup>3</sup>	7891116
	65160/000	02	0,081	161234

Contents / Contenido:  
 1 Frying Pan / Sartén Ø 26cm - 2,20l  
 1 Sauce Pan / Olla Ø 16cm - 1,70l  
 1 Casserole / Cacerola Ø 24cm - 4,40l  
 1 Deep Casserole / Cacerola Honda Ø 20cm - 3,50l



Exclusive material for legal entities/corporate clients.  
Material exclusivo para clientes persona jurídica.

# Grano Compact



TecnoHeat



The elegance of the Grano cookware combined with the safety and comfort of silicone handles. Exclusive technology that ensures an even more enjoyable experience while cooking.

La elegancia de las ollas Grano con la seguridad y comodidad de los mangos de silicona. Tecnologías exclusivas que garantizan una experiencia todavía más placentera ante el horno o la cocina.



**TecnoHeat**

Temperature and performance balance as well as fast cooking.

Equilibrio en la temperatura y desempeño y velocidad en la cocción.





NEW RELEASE  
LANZAMIENTO

**COOKWARE SET  
BATERÍA DE COCINA  
3 PC./PZAS.**

Ref.	Un.	m <sup>3</sup>	7891116
65240/200	02	0,053	174050

Contents / Contenido:  
 1 Deep Casserole / Cacerola Honda Ø 20cm - 3,80l  
 1 Stock Pot / Olla Alta Ø 16cm - 2,20l  
 1 Stock Pot / Olla Alta Ø 24cm - 7,70l





Exclusive material for legal entities/corporate clients.  
Material exclusivo para clientes persona jurídica.

# Duo Silicone



The tri-ply base now has silicone - coated handles to insulate the heat and ensure greater safety and comfort when cooking. It is the right choice for those who want durability and convenience combined in a single product.

El fondo triple adquiere asas y mangos revestidos de silicona, que aíslan el calor y garantizan más seguridad y comodidad en la preparación de las recetas. La elección adecuada para quienes buscan durabilidad y practicidad en un solo producto.





SAUTE PAN  
SARTÉN

	Ref.	Un.	m <sup>3</sup>	7891116
Ø 20cm - 2,10l	62480/200	04	0,047	066737
Ø 24cm - 3,30l	62480/240	04	0,072	072769



SAUCE PAN  
OLLA

	Ref.	Un.	m <sup>3</sup>	7891116
Ø 16cm - 1,40l	62481/160	04	0,042	066744
Ø 20cm - 2,80l	62481/200	04	0,047	066751



CASSEROLE  
CACEROLA

	Ref.	Un.	m <sup>3</sup>	7891116
Ø 16cm - 1,40l	62483/160	04	0,023	066768
Ø 20cm - 2,80l	62483/200	04	0,035	066775
Ø 24cm - 4,70l	62483/240	04	0,059	066782



DEEP CASSEROLE  
CACEROLA HONDA

	Ref.	Un.	m <sup>3</sup>	7891116
Ø 16cm - 1,80l	62484/160	04	0,030	066799
Ø 20cm - 3,60l	62484/200	04	0,043	066805
Ø 24cm - 6,00l	62484/240	04	0,070	066812



STOCK POT  
OLLA ALTA

	Ref.	Un.	m <sup>3</sup>	7891116
Ø 20cm - 4,50l	62485/200	04	0,059	066829
Ø 24cm - 7,70l	62485/240	04	0,082	066836



Exclusive material for legal entities/corporate clients.  
Material exclusivo para clientes persona jurídica.





**DEEP SAUCE PAN  
OLLA HONDA**

	Ref.	Un.	m <sup>3</sup>	7891116
Ø 16cm - 2,20l	62487/160	04	0,055	066843



**STEAMER  
VAPORERA**

	Ref.	Un.	m <sup>3</sup>	7891116
Ø 16cm - 1,60l	62490/160	04	0,030	066850
Ø 20cm - 3,10l	62490/200	04	0,035	066867



**MILK BOILER  
HERVIDOR**

	Ref.	Un.	m <sup>3</sup>	7891116
Ø 14cm - 2,00l	62492/140	04	0,030	111758



**PASTA INSERT SET  
JUEGO COZI-PASTA  
2 PC./PZAS.**

	Ref.	Un.	m <sup>3</sup>	7891116
	65480/400	02	0,054	069837

Contents / Contenido:  
1 Stock Pot / Olla Alta Ø 24cm - 7,70l  
1 Pasta Insert / Cozi-Pasta Ø 24cm - 7,90l



**COOKWARE SET  
BATERÍA DE COCINA  
4 PC./PZAS.**

Ref.	Un.	m <sup>3</sup>	7891116
65480/086	02	0,080	103104

**Contents / Contenido:**

- 1 Sauce Pan / Olla Ø 16cm - 1,40l
- 1 Deep Casserole / Cacerola Honda Ø 16cm - 1,80l
- 1 Deep Casserole / Cacerola Honda Ø 20cm - 3,60l
- 1 Deep Casserole / Cacerola Honda Ø 24cm - 6,00l



**COOKWARE SET  
BATERÍA DE COCINA  
5 PC./PZAS.**

Ref.	Un.	m <sup>3</sup>	7891116
65480/036	02	0,094	079973

**Contents / Contenido:**

- 1 Deep Sauce Pan / Olla Honda Ø 16cm - 2,20l
- 1 Deep Casserole / Cacerola Honda Ø 20cm - 3,60l
- 1 Deep Casserole / Cacerola Honda Ø 24cm - 6,00l
- 1 Casserole / Cacerola Ø 20cm - 2,80l
- 1 Saute Pan / Sartén Ø 24cm - 3,30l



**COOKWARE SET  
BATERÍA DE COCINA  
5 PC./PZAS.**

Ref.	Un.	m <sup>3</sup>	7891116
65480/010	02	0,081	067628

**Contents / Contenido:**

- 1 Saute Pan / Sartén Ø 20cm - 2,10l
- 1 Casserole / Cacerola Ø 24cm - 4,70l
- 1 Deep Casserole / Cacerola Honda Ø 20cm - 3,60l
- 1 Sauce Pan / Olla Ø 16cm - 1,40l
- 1 Steamer / Vaporera Ø 20cm - 3,10l

# Professional



With larger handles, the Professional line provides a firm and safe grip for the daily routine of more demanding kitchens. The tri-ply base improves cooking performance and the stainless steel looks beautiful on the table.

Con mangos y asas más anchos, la línea Professional proporciona firmeza y seguridad en el día a día de las cocinas más exigentes. El fondo triple mejora el desempeño de la cocción y el acero inoxidable también se luce sobre la mesa.



SAUCE PAN  
OLLA

	Ref.	Un.	m <sup>3</sup>	7891116
Ø 14cm - 1,10l	62621/140	04	0,030	126806
Ø 16cm - 1,40l	62621/160	04	0,054	012444
Ø 20cm - 2,90l	62621/200	04	0,059	012451
Ø 24cm - 4,70l	62621/240	04	0,083	012468



CASSEROLE  
CACEROLA

	Ref.	Un.	m <sup>3</sup>	7891116
Ø 16cm - 1,40l	62623/160	04	0,030	124758
Ø 20cm - 2,90l	62623/200	04	0,049	012482
Ø 24cm - 4,70l	62623/240	04	0,071	012499
Ø 28cm - 7,10l	62623/280	04	0,079	012505



DEEP CASSEROLE  
CACEROLA HONDA

	Ref.	Un.	m <sup>3</sup>	7891116
Ø 16cm - 1,80l	62624/160	04	0,033	012512
Ø 20cm - 3,60l	62624/200	04	0,061	012529
Ø 24cm - 6,10l	62624/240	04	0,083	012536
Ø 28cm - 8,40l	62624/280	04	0,101	012543



STOCK POT  
OLLA ALTA

	Ref.	Un.	m <sup>3</sup>	7891116
Ø 20cm - 4,60l	62625/200	04	0,070	012550
Ø 24cm - 7,80l	62625/240	04	0,099	012567
Ø 28cm - 11,90l	62625/280	04	0,118	012574



DEEP SAUCE PAN  
OLLA HONDA

	Ref.	Un.	m <sup>3</sup>	7891116
Ø 16cm - 2,20l	62627/160	04	0,045	067413





**STEAMER  
VAPORERA**

	Ref.	Un.	m <sup>3</sup>	7891116
Ø 16cm - 1,60l	62630/160	04	0,030	012581
Ø 20cm - 3,20l	62630/200	04	0,053	012598
Ø 24cm - 5,60l	62630/240	04	0,083	012604



**PASTA INSERT  
COZI-PASTA**

	Ref.	Un.	m <sup>3</sup>	7891116
Ø 20cm - 4,60l	62634/200	04	0,079	020234



**PASTA INSERT SET  
JUEGO COZI-PASTA  
2 PC./PZAS.**

	Ref.	Un.	m <sup>3</sup>	7891116
	65620/400	04	0,101	083673
	65620/410	04	0,048	083680

Contents / Contenido: 65620/400  
1 Stock Pot | Olla Alta Ø 24cm - 7,80l  
1 Pasta Insert | Cozi-pasta Ø 24cm - 8,00l

Contents / Contenido: 65620/410  
1 Stock Pot | Olla Alta Ø 20cm - 4,60l  
1 Pasta Insert | Cozi-pasta Ø 20cm - 4,60l



**COOKWARE SET  
BATERÍA DE COCINA  
4 PC./PZAS.**

	Ref.	Un.	m <sup>3</sup>	7891116
	65620/216	02	0,080	104675

Contents / Contenido:  
1 Sauce Pan / Olla Ø 16cm - 1,40l  
1 Casserole / Cacerola Ø 20cm - 2,90l  
1 Deep Casserole / Cacerola Honda Ø 20cm - 3,60l  
1 Deep Casserole / Cacerola Honda Ø 24cm - 6,10l



**COOKWARE SET  
BATERÍA DE COCINA  
5 PC./PZAS.**

Ref.	Un.	m <sup>3</sup>	7891116
65620/186	02	0,080	103135

**Contents / Contenido:**

- 1 Sauce Pan / Olla Ø 16cm - 1,40l
- 1 Deep Casserole / Cacerola Honda Ø 16cm - 1,80l
- 1 Deep Casserole / Cacerola Honda Ø 20cm - 3,60l
- 1 Deep Casserole / Cacerola Honda Ø 24cm - 6,10l
- 1 Casserole / Cacerola Ø 20cm - 2,90l



**COOKWARE SET  
BATERÍA DE COCINA  
5 PC./PZAS.**

Ref.	Un.	m <sup>3</sup>	7891116
65620/010	02	0,081	081310

**Contents / Contenido:**

- 1 Contents / Contenido:
- 1 Frying Pan / Sartén Ø 26cm - 2,00l
- 1 Sauce Pan / Olla Ø 16cm - 1,40l
- 1 Casserole / Cacerola Ø 24cm - 4,70l
- 1 Deep Casserole / Cacerola Honda Ø 20cm - 3,60l
- 1 Steamer / Vaporera Ø 20cm - 3,20l





Exclusive material for legal entities/corporate clients.  
Material exclusivo para clientes persona jurídica.



FRYING PAN WITHOUT TRI-PLY BASE  
SARTÉN SIN FONDO TRIPLE

	Ref.	Un.	m <sup>2</sup>	7891116
Ø 26cm - 2,00l	62636/261	04	0,031	041291



STOCK POT  
OLLA CON TAPA

	Ref.	Un.	m <sup>2</sup>	7891116
Ø 20cm - 5,70l	62648/200	01	0,017	047019
Ø 24cm - 9,60l	62648/240	01	0,023	047026
Ø 28cm - 15,70l	62648/280	01	0,037	047033



CASSEROLE WITHOUT LID  
OLLA SIN TAPA

	Ref.	Un.	m <sup>2</sup>	7891116
Ø 40cm - 23,00l	62643/400*	01	0,044	015124
Ø 45cm - 35,00l	62643/450*	01	0,083	038963



SAUCE POT WITHOUT LID  
CACEROLA BAJA SIN TAPA

	Ref.	Un.	m <sup>2</sup>	7891116
Ø 36cm - 22,30l	62644/360*	01	0,042	067420





LID  
TAPA

	Ref.	Un.	m <sup>3</sup>	7891116
Ø 36cm	62639/360	01	0,013	067444
Ø 40cm	62649/400*	01	0,024	028568
Ø 45cm	62649/450*	01	0,027	038970
Ø 50cm	62649/500*	01	0,024	125328



STOCK POT WITHOUT LID  
OLLA SIN TAPA

	Ref.	Un.	m <sup>3</sup>	7891116
Ø 36cm - 28,00l	62646/360*	01	0,062	067437



STOCK POT WITHOUT LID  
OLLA SIN TAPA

	Ref.	Un.	m <sup>3</sup>	7891116
Ø 40cm - 30,00l	62645/400*	01	0,059	015155
Ø 50cm - 58,00l	62645/500*	01	0,100	015162



PASTA INSERT  
RECIPIENTE PARA COZI-PASTA

	Ref.	Un.	m <sup>3</sup>	7891116
190 x 260 x 205mm	62620/991	01	0,015	073513

\* Imported Product / Producto Importado



STOCK POT WITH 4 PASTA INSERT  
COZI-PASTA CON 4 ESCURRIDORES

	Ref.	Un.	m <sup>3</sup>	7891116
Ø 30cm - 13,50l	65620/411	01	0,042	073452

Includes four containers for cooking four different types of pasta.

Posee cuatro recipientes permitiendo la cocción de cuatro tipos de pasta.

Auxiliary handles for better handling.

Asas para ayudar en su manejo.

Hole for draining noodles.

Agujeros para escurrir tallarines.

Tubular stainless steel side handles for professional handling.

Asas tubulares de acero inoxidable para uso profesional.

No tri-ply base.

Sin fondo triple.



FRYING PAN  
SARTÉN

	Ref.	Un.	m <sup>3</sup>	7891116
Ø 20cm - 1,10l	62635/200	04	0,025	029237
Ø 26cm - 2,00l	62635/260	04	0,046	029244
Ø 30cm - 2,90l	62635/300	04	0,053	029251

Ceramic Coating  
Revestimiento Cerámico



FRYING PAN  
SARTÉN

	Ref.	Un.	m <sup>3</sup>	7891116
Ø 20cm - 1,10l	62635/206	04	0,025	139356
Ø 26cm - 2,00l	62635/266	04	0,046	080597
Ø 30cm - 2,90l	62635/306	04	0,053	139363

Ceramic Coating  
Revestimiento Cerámico



NEW RELEASE  
LANZAMIENTO

FRYING PAN  
SARTÉN

	Ref.	Un.	m <sup>3</sup>	7891116
Ø 20cm - 1,10l	62635/014	04	0,025	173435
Ø 26cm - 2,00l	62635/024	04	0,046	173442
Ø 30cm - 2,90l	62635/034	04	0,053	173459

Ceramic Coating  
Revestimiento Cerámico



FRYING PAN  
SARTÉN

	Ref.	Un.	m <sup>3</sup>	7891116
Ø 30cm - 2,90l	62635/304	04	0,053	101629

Non-Stick Coating  
Revestimiento Antiadherente



FRYING PAN  
SARTÉN

	Ref.	Un.	m <sup>3</sup>	7891116
Ø 20cm - 1,10l	62635/207	04	0,025	101636
Ø 26cm - 2,00l	62635/267	04	0,046	101643
Ø 30cm - 2,90l	62635/307	04	0,053	101650

Ceramic Coating  
Revestimiento Cerámico



DEEP FRYING PAN  
SARTÉN HONDA

	Ref.	Un.	m <sup>3</sup>	7891116
Ø 30cm - 3,80l	62637/306	04	0,061	123997







# Solar



Shine brightly in your kitchen. With a classic design, these items stand out for their durability and value for money.

The secret is combining stainless steel with the tri-ply base: the right choice for those who want resistance and quality combined in the kitchen.

Para brillar en la cocina. Con diseño clásico, las piezas se destacan por la durabilidad y economía.

El secreto es la combinación del acero inoxidable y el fondo triple - la opción correcta para quienes buscan reunir resistencia y calidad en la cocina.



SAUTE PAN  
SARTÉN

	Ref.	Un.	m <sup>3</sup>	7891116
Ø 20cm - 2,10l	62500/200	04	0,042	002155
Ø 24cm - 3,30l	62500/240	04	0,059	001707
Ø 28cm - 4,80l	62500/280	04	0,079	005248



COCOTTE PAN  
OLLA COCOTE

	Ref.	Un.	m <sup>3</sup>	7891116
Ø 14cm - 1,10l	62501/140	04	0,031	005255



SAUCE PAN  
OLLA

	Ref.	Un.	m <sup>3</sup>	7891116
Ø 16cm - 1,40l	62501/160	04	0,030	000250
Ø 20cm - 2,90l	62501/200	04	0,047	000267
Ø 24cm - 4,70l	62501/240	04	0,067	001639



CASSEROLE  
CACEROLA

	Ref.	Un.	m <sup>3</sup>	7891116
Ø 16cm - 1,40l	62503/160	04	0,023	000748
Ø 20cm - 2,90l	62503/200	04	0,028	001264
Ø 24cm - 4,70l	62503/240	04	0,046	000960
Ø 28cm - 7,10l	62503/280	04	0,061	004036



DEEP CASSEPOLE  
CACEROLA HONDA

	Ref.	Un.	m <sup>3</sup>	7891116
Ø 16cm - 1,80l	62504/160	04	0,023	001455
Ø 20cm - 3,60l	62504/200	04	0,037	000274
Ø 24cm - 6,10l	62504/240	04	0,058	000755
Ø 28cm - 8,40l	62504/280	04	0,082	001462



STOCK POT  
OLLA ALTA

	Ref.	Un.	m <sup>3</sup>	7891116
Ø 20cm - 4,60l	62505/200	04	0,042	000458
Ø 24cm - 7,80l	62505/240	04	0,071	002162
Ø 28cm - 11,90l	62505/280	04	0,099	002667



DEEP SAUCE PAN  
OLLA HONDA

	Ref.	Un.	m <sup>3</sup>	7891116
Ø 14cm - 1,50l	62507/140	04	0,031	034804
Ø 16cm - 2,20l	62507/160	04	0,040	034811



HIGH STOCK POT  
OLLA ALTA

	Ref.	Un.	m <sup>3</sup>	7891116
Ø 20cm - 5,70l	62508/200	04	0,055	040034
Ø 24cm - 9,60l	62508/240	02	0,054	044681
Ø 28cm - 15,70l	62508/280	02	0,070	044674



MILK BOILER  
HERVIDOR

	Ref.	Un.	m <sup>3</sup>	7891116
Ø 14cm - 2,00l	62512/145	04	0,030	129692



**STEAMER  
VAPORERA**

	Ref.	Un.	m <sup>3</sup>	7891116
Ø 16cm - 1,60l	62510/160	04	0,023	005262
Ø 20cm - 3,20l	62510/200	04	0,042	000052
Ø 24cm - 5,60l	62510/240	04	0,058	005279



**PASTA INSERT  
COZI-PASTA**

	Ref.	Un.	m <sup>3</sup>	7891116
Ø 24cm - 8,00l	62514/240	04	0,083	008942

Perfect - Fit Lid.  
Tapa con encaje perfecto.

Spaghetti Straining Holes.  
Agujeros para escurrir los tallarines.



**SPAGHETTI POT  
OLLA PARA SPAGHETTI**

	Ref.	Un.	m <sup>3</sup>	7891116
Ø 24cm - 7,70l	62517/240	04	0,083	043042
Ø 24cm - 7,70l	62517/241*	01	0,030	043059

\*Plastic Bag | Bolsa Plástica



**STEAMER SET  
OLLA VAPORERA  
2 PC./PZAS.**

	Ref.	Un.	m <sup>3</sup>	7891116
	65500/300	04	0,030	005309

Contents / Contenido:  
1 Deep Casserole / Cacerola Honda Ø 16cm - 1,80l  
1 Steamer / Vaporera Ø 16cm - 1,60l





Exclusive material for legal entities/corporate clients.  
Material exclusivo para clientes persona jurídica.



**PASTA INSERT SET  
JUEGO COZI-PASTA  
2 PC./PZAS.**

Ref.	Un.	m <sup>3</sup>	7891116
65500/400	04	0,083	008959
65500/410	04	0,055	020630

Contents / Contenido: 65500/400  
1 Pasta Insert / Cozi-pasta Ø 24cm - 8,00l  
1 Stock Pot / Olla Alta Ø 24cm - 7,80l

Contents / Contenido: 65500/410  
1 Pasta Insert / Cozi-pasta Ø 20cm - 4,60l  
1 Stock Pot / Olla Alta Ø 20cm - 4,60l



**COOKWARE SET  
BATERÍA DE COCINA  
3 PC./PZAS.**

Ref.	Un.	m <sup>3</sup>	7891116
65510/740	02	0,055	130070

Contents / Contenido:  
1 Casserole / Cacerola Ø 20cm - 2,90l  
1 Deep Casserole / Cacerola Honda Ø 16cm - 1,80l  
1 Deep Casserole / Cacerola Honda Ø 20cm - 3,60l



**COOKWARE SET  
BATERÍA DE COCINA  
3 PC./PZAS.**

Ref.	Un.	m <sup>3</sup>	7891116
65500/130	02	0,075	165768

Contents / Contenido:  
1 Deep Casserole / Cacerola Honda Ø 20cm - 3,60l  
1 Sauce Pan / Olla Ø 16cm - 1,40l  
1 Frying Pan / Sartén Ø 20cm - 1,30l



**COOKWARE SET  
BATERÍA DE COCINA  
4 PC./PZAS.**

Ref.	Un.	m <sup>3</sup>	7891116
65500/120	02	0,075	165751

Contents / Contenido:  
1 Deep Casserole / Cacerola Honda Ø 20cm - 3,60l  
1 Casserole / Cacerola Ø 24cm - 4,70l  
1 Sauce Pan / Olla Ø 16cm - 1,40l  
1 Frying Pan Non-Stick Coating / Sartén  
Revestimiento Antiadherente Ø 24cm - 2,10l





**COOKWARE SET  
BATERÍA DE COCINA  
4 PC./PZAS.**

Ref.	Un.	m <sup>3</sup>	7891116
65510/760	02	0,061	130094

Contents / Contenido:  
 1 Deep Casserole / Cacerola Honda Ø 16cm - 1,80l  
 1 Deep Casserole / Cacerola Honda Ø 20cm - 3,60l  
 1 Sauce Pan / Olla Ø 16cm - 1,40l  
 1 Sauce Pan / Olla Ø 20cm - 2,90l



**COOKWARE SET  
BATERÍA DE COCINA  
6 PC./PZAS.**

Ref.	Un.	m <sup>3</sup>	7891116
65500/000	02	0,075	006412

Contents / Contenido:  
 1 Saute Pan / Sartén Ø 20cm - 2,10l  
 1 Casserole / Cacerola Ø 16cm - 1,40l  
 1 Casserole / Cacerola Ø 20cm - 2,90l  
 1 Casserole / Cacerola Ø 24cm - 4,70l  
 1 Deep Casserole / Cacerola Honda Ø 20cm - 3,60l  
 1 Bake & Roast Pan / Asadera 295x192 mm



**COOKWARE SET  
BATERÍA DE COCINA  
6 PC./PZAS.**

Ref.	Un.	m <sup>3</sup>	7891116
65500/040	02	0,101	001578

Contents / Contenido:  
 1 Saute Pan / Sartén Ø 20cm - 2,10l  
 1 Sauce Pan / Olla Ø 20cm - 2,90l  
 1 Casserole / Cacerola Ø 16cm - 1,40l  
 1 Deep Casserole / Cacerola Honda Ø 20cm - 3,60l  
 1 Stock Pot / Olla Alta Ø 20cm - 4,60l  
 1 Steamer / Vaporera Ø 20cm - 3,20l



**COOKWARE SET  
BATERÍA DE COCINA  
6 PC./PZAS.**

Ref.	Un.	m <sup>3</sup>	7891116
65510/200	02	0,075	061589

**Contents / Contenido:**

- 1 Deep Casserole / Cacerola Honda Ø 20cm - 3,60l
- 1 Casserole / Cacerola Ø 24cm - 4,70l
- 1 Frying Pan / Sartén Ø 20cm - 2,20l
- 1 Milk Boiler / Hervidor Ø 12cm - 1,40l
- 1 Sauce Pan / Olla Ø 16cm - 1,40l
- 1 Steamer / Vaporera Ø 20cm - 3,20l



**COOKWARE UNIQUE PRICE  
OLLAS PRECIO UNICO  
12 PC./PZAS.**

Ref.	Un.	m <sup>3</sup>	7891116
*65510/830	12	0,150	149430

**Contents / Contenido:**

- 4 Casserole / Cacerola Ø 24cm - 4,70l
- 4 Casserole / Cacerola Ø 28cm - 7,10l
- 4 Deep Casserole / Cacerola Honda Ø 24cm - 6,10l



**COOKWARE UNIQUE PRICE  
OLLAS PRECIO UNICO  
16 PC./PZAS.**

Ref.	Un.	m <sup>3</sup>	7891116
*65510/770	16	0,093	130100

**Contents / Contenido:**

- 4 Casserole / Cacerola Ø 20cm - 2,90l
- 4 Deep Casserole / Cacerola Honda Ø 16cm - 1,80l
- 4 Deep Casserole / Cacerola Honda Ø 20cm - 3,60l
- 4 Sauce Pan / Olla Ø 16cm - 1,40l



# Solar Bakelite Baquelita



The solidness of stainless steel combined with the safety and convenience of Bakelite.

Used on the handles and knobs, this material insulates heat, makes handling easier and ensures greater agility and convenience in the kitchen.

Classic and innovative.

La solidez del acero inoxidable aliada a la seguridad y practicidad de la baquelita.

Presente en los mangos, asas y pomos, el material aísla el calor, facilita el manejo y garantiza más agilidad y practicidad en la cocina.

Clásico e innovador.



SAUTE PAN  
SARTÉN

	Ref.	Un.	m <sup>3</sup>	7891116
Ø 20cm - 2,10l	62720/200	04	0,055	045558
Ø 24cm - 3,30l	62720/240	04	0,092	045367



SAUCE PAN  
OLLA

	Ref.	Un.	m <sup>3</sup>	7891116
Ø 20cm - 2,90l	62721/200	04	0,071	045381
Ø 24cm - 4,70l	62721/240	04	0,083	045398



CASSEROLE  
CACEROLA

	Ref.	Un.	m <sup>3</sup>	7891116
Ø 20cm - 2,90l	62723/200	04	0,049	045404
Ø 24cm - 4,70l	62723/240	04	0,071	045411
Ø 28cm - 7,10l	62723/280	04	0,090	045428



DEEP CASSEROLE  
CACEROLA HONDA

	Ref.	Un.	m <sup>3</sup>	7891116
Ø 16cm - 1,80l	62724/160	04	0,035	045435
Ø 20cm - 3,60l	62724/200	04	0,061	045442
Ø 24cm - 6,10l	62724/240	04	0,083	045459
Ø 28cm - 8,40l	62724/280	04	0,101	045466



STOCK POT  
OLLA ALTA

	Ref.	Un.	m <sup>3</sup>	7891116
Ø 20cm - 4,60l	62725/200	04	0,070	045473
Ø 24cm - 7,80l	62725/240	04	0,099	045480
Ø 28cm - 11,90l	62725/280	04	0,118	045497



DEEP SAUCE PAN  
OLLA HONDA

	Ref.	Un.	m <sup>3</sup>	7891116
Ø 16cm - 2,20l	62727/160	04	0,071	045503



**STEAMER  
VAPORERA**

	Ref.	Un.	m <sup>3</sup>	7891116
Ø 20cm - 3,20l	62730/200	04	0,054	045527



**PASTA INSERT SET  
JUEGO COZI-PASTA  
2 PC./PZAS.**

	Ref.	Un.	m <sup>3</sup>	7891116
	65720/410	04	0,075	083666

Contents / Contenido:  
 1 Pasta Insert / Cozi-pasta Ø 20cm - 4,60l  
 1 Stock Pot / Olla Alta Ø 20cm - 4,60l





**COOKWARE SET  
BATERÍA DE COCINA  
3 PC./PZAS.**

Ref.	Un.	m <sup>3</sup>	7891116
65720/740	02	0,067	149461

Contents / Contenido:  
 1 Casserole / Cacerola Ø 20cm - 2,90l  
 1 Deep Casserole / Cacerola Honda Ø 16cm - 1,80l  
 1 Deep Casserole / Cacerola Honda Ø 20cm - 3,60l



**COOKWARE SET  
BATERÍA DE COCINA  
6 PC./PZAS.**

Ref.	Un.	m <sup>3</sup>	7891116
65720/000	02	0,097	045251

Contents / Contenido:  
 1 Saute Pan / Sartén Ø 20cm - 2,10l  
 1 Casserole / Cacerola Ø 20cm - 2,90l  
 1 Casserole / Cacerola Ø 24cm - 4,70l  
 1 Deep Casserole / Cacerola Honda Ø 16cm - 1,80l  
 1 Deep Casserole / Cacerola Honda Ø 20cm - 3,60l  
 1 Bake & Roast Pan / Asadera 295 x 192mm



**COOKWARE SET  
BATERÍA DE COCINA  
5 PC./PZAS.**

Ref.	Un.	m <sup>3</sup>	7891116
65720/010	02	0,081	081303

Contents / Contenido:  
 1 Steamer / Vaporera Ø 20cm - 3,20l  
 1 Sauce Pan / Olla Ø 16cm - 1,80l  
 1 Deep Casserole / Cacerola Honda Ø 20cm - 3,60l  
 1 Casserole / Cacerola Ø 24cm - 4,70l  
 1 Saute Pan / Sartén Ø 20cm - 2,10l



**COOKWARE UNIQUE PRICE  
OLLAS PRECIO UNICO  
16 PC./PZAS.**

Ref.	Un.	m <sup>3</sup>	7891116
65720/770	16	0,126	149478

Contents / Contenido:  
 4 Casserole / Cacerola Ø 20cm - 2,90l  
 4 Deep Casserole / Cacerola Honda Ø 16cm - 1,80l  
 4 Deep Casserole / Cacerola Honda Ø 20cm - 3,60l  
 4 Deep Sauce Pan / Olla Honda Ø 16cm - 2,20l

Price by unit | Precio por unidad



# Solar Ceramic



Who says healthy food can't be tasty too? The Solar Ceramic line features a ceramic coating that keeps food moist while reducing the need to cook with fat.

A healthier daily routine.

¿Quién dijo que la comida sana no puede ser sabrosa? La línea Solar Ceramic trae un revestimiento cerámico que retiene la humedad de los alimentos y reduce la necesidad de grasa en la cocción.

Es más salud en el día a día.



**MILK BOILER  
HERVIDOR**

	Ref.	Un.	m <sup>3</sup>	7891116
Ø 14cm - 2,00l	62132/146	04	0,030	139349



**COOKWARE SET  
BATERÍA DE COCINA  
4 PC./PZAS.**

	Ref.	Un.	m <sup>3</sup>	7891116
	65120/026	02	0,082	138816

Contents / Contenido:  
 1 Casserole / Cacerola Ø 24cm - 4,70l  
 1 Deep Casserole / Cacerola Honda Ø 20cm - 3,60l  
 1 Sauce Pan / Olla Ø 16cm - 1,40l  
 1 Saute Pan / Sartén Ø 20cm - 2,00l



# Solar Silicone



Silicone, used on the handles and knobs, adds a special touch to the solidness of stainless steel.

These items combine the high performance and safety of the tri-ply base with easy handling.

Traditional and contemporary at the same time.

Presente en mangos, asas y pomos, la silicona le da un toque especial a la solidez del acero inoxidable.

Las piezas combinan el alto desempeño y la seguridad del fondo triple con la agilidad del manejo.

Tradicional y moderna al mismo tiempo.



		Ref.	Un.	m <sup>3</sup>	7891116
Ø 16cm - 1,40l		62121/163	04	0,042	129234



		Ref.	Un.	m <sup>3</sup>	7891116
Ø 20cm - 2,90l		62123/203	04	0,033	129241



		Ref.	Un.	m <sup>3</sup>	7891116
Ø 16cm - 1,80l		62124/163	04	0,003	129258
Ø 20cm - 3,60l		62124/203	04	0,046	129265
Ø 24cm - 6,10l		62124/243	04	0,070	129272



		Ref.	Un.	m <sup>3</sup>	7891116
Ø 20cm - 4,60l		62125/203	04	0,060	129289





NEW RELEASE  
LANZAMIENTO

**COOKWARE SET  
BATERÍA DE COCINA  
4 PC./PZAS.**

Ref.	Un.	m <sup>3</sup>	7891116
65120/030	02	0,075	173817

Contents / Contenido:  
 1 Sauce pan / Olla Ø 16cm - 1,40l  
 1 Casserole / Cacerola Ø 24cm - 4,70l  
 1 Deep casserole / Cacerola honda Ø 20cm - 3,60l  
 1 Frying pan / Sartén Ø 20cm - 1,30l



NEW RELEASE  
LANZAMIENTO

**COOKWARE SET  
BATERÍA DE COCINA  
5 PC./PZAS.**

Ref.	Un.	m <sup>3</sup>	7891116
65120/040	02	0,075	173800

Contents / Contenido:  
 1 Sauce pan / Olla Ø 16cm - 1,80l  
 1 Casserole / Cacerola Ø 24cm - 4,70l  
 1 Deep casserole / Cacerola honda Ø 20cm - 3,60l  
 1 Frying pan / Sartén Ø 24cm - 2,10l  
 1 Milk Boiler / Hervidor Ø 14cm - 2,00l









NEW RELEASE  
LANZAMIENTO

WOK

	Ref.	Un.	m <sup>3</sup>	7891116
Ø 28cm - 3,30l	62138/280	02	0,042	169421



NEW RELEASE  
LANZAMIENTO

WOK

	Ref.	Un.	m <sup>3</sup>	7891116
Ø 28cm - 3,30l	62138/282	02	0,042	169438



NEW RELEASE  
LANZAMIENTO

WOK

	Ref.	Un.	m <sup>3</sup>	7891116
Ø 28cm - 3,30l	62138/288	02	0,042	169452



NEW RELEASE  
LANZAMIENTO

FRYING PAN  
SARTÉN

	Ref.	Un.	m <sup>3</sup>	7891116
Ø 20cm - 1,30l	62135/200	04	0,025	173732
Ø 24cm - 2,10l	62135/240	04	0,046	173749



NEW RELEASE  
LANZAMIENTO

FRYING PAN  
SARTÉN

	Ref.	Un.	m <sup>3</sup>	7891116
Ø 20cm - 1,30l	62135/207	04	0,025	173787
Ø 24cm - 2,10l	62135/247	04	0,046	173794





CASSEROLE  
CACEROLA

	Ref.	Un.	m <sup>3</sup>	7891116
Ø 30cm - 8,90l	62123/300	01	0,016	158852



STOCK POT  
OLLA ALTA

	Ref.	Un.	m <sup>3</sup>	7891116
Ø 28cm - 11,40l	62125/280	01	0,021	158869
Ø 30cm - 15,20l	62125/300	01	0,027	158876



STEAMER SET  
OLLA VAPORERA  
2 PC./PZAS.

	Ref.	Un.	m <sup>3</sup>	7891116
Ø 20cm - 3,60l	65120/100	01	0,012	170502

Contents / Contenido:  
1 Deep Casserole / Cacerola Honda Ø 20cm - 3,60l  
1 Steamer / Vaporera Ø 20cm - 2,30l



PASTA INSERT SET  
OLLA PARA SPAGHETTI  
2 PC./PZAS.

	Ref.	Un.	m <sup>3</sup>	7891116
Ø 24cm - 7,80l	62137/240	01	0,016	158883

Contents / Contenido:  
1 Stock pot / Olla alta Ø 24cm - 7,80l  
1 Locking strainer / Ecurridor



# Una



The handles are welded to the body, making the design stand out and ensuring safety and resistance in this product's daily use.

The glass lid makes cooking easier because you can monitor the food without lifting the lid. Contemporary, practical and unique: this is the Una line.

Los mangos soldados al cuerpo triple realzan el diseño y garantizan seguridad y resistencia en el uso diario.

La tapa de vidrio facilita la preparación de las recetas sin necesidad de abrir la olla.









SAUCE PAN  
OLLA

	Ref.	Un.	m <sup>3</sup>	7891116
Ø 16cm - 1,40l	62281/160	04	0,033	149065



CASSEROLE  
CACEROLA

	Ref.	Un.	m <sup>3</sup>	7891116
Ø 16cm - 1,40l	62283/160	04	0,025	148976
Ø 20cm - 2,90l	62283/200	04	0,036	148983
Ø 24cm - 4,80l	62283/240	04	0,055	148990



DEEP CASSEROLE  
CACEROLA HONDA

	Ref.	Un.	m <sup>3</sup>	7891116
Ø 16cm - 1,80l	62284/160	04	0,030	149003
Ø 20cm - 3,60l	62284/200	04	0,041	149010
Ø 24cm - 6,10l	62284/240	04	0,060	149027



STOCK POT  
OLLA ALTA

	Ref.	Un.	m <sup>3</sup>	7891116
Ø 16cm - 2,20l	62285/160	04	0,033	149034
Ø 20cm - 4,60l	62285/200	04	0,055	149041
Ø 24cm - 7,70l	62285/240	04	0,066	149058



FRYING PAN  
SARTÉN

	Ref.	Un.	m <sup>3</sup>	7891116
Ø 24cm - 2,10l	62295/240	04	0,076	149072



**COOKWARE SET  
BATERÍA DE COCINA  
3 PC./PZAS.**

Ref.	Un.	m <sup>3</sup>	7891116
65280/300	02	0,067	149089

Contents / Contenido:  
 1 Sauce Pan / Olla Ø 16cm - 1,40l  
 1 Casserole / Cacerola Ø 24cm - 4,80l  
 1 Deep Casserole / Cacerola Honda Ø 20cm - 3,60l



**COOKWARE SET  
BATERÍA DE COCINA  
4 PC./PZAS.**

Ref.	Un.	m <sup>3</sup>	7891116
65280/310	02	0,067	149096

Contents / Contenido:  
 1 Sauce Pan / Olla Ø 16cm - 1,40l  
 1 Casserole / Cacerola Ø 24cm - 4,80l  
 1 Deep Casserole / Cacerola Honda Ø 20cm - 3,60l  
 1 Frying Pan / Sartén Ø 24cm - 2,10l

# Una Ceramic



Who says healthy food can't be tasty too? The Una Ceramic line features a ceramic coating that keeps food moist while reducing the need to cook with fat. A healthier daily routine.

¿Quién dijo que la comida sana no puede ser sabrosa? La línea Una Ceramic trae un revestimiento cerámico que retiene la humedad de los alimentos y reduce la necesidad de grasa en la cocción. Es más salud en el día a día.



NEW RELEASE  
LANZAMIENTO

**COOKWARE SET  
BATERÍA DE COCINA  
4 PC./PZAS.**

Ref.	Un.	m <sup>3</sup>	7891116
65280/312	02	0,067	170304

Contents / Contenido:  
 1 Sauce Pan / Olla Ø 16cm - 1,40l  
 1 Casserole / Cacerola Ø 24cm - 4,80l  
 1 Deep Casserole / Cacerola honda Ø 20cm - 3,60l  
 1 Frying pan / Sartén Ø 24cm - 2,10l



NEW RELEASE  
LANZAMIENTO

**COOKWARE SET  
BATERÍA DE COCINA  
4 PC./PZAS.**

Ref.	Un.	m <sup>3</sup>	7891116
65280/313	02	0,067	170311

Contents / Contenido:  
 1 Sauce Pan / Olla Ø 16cm - 1,40l  
 1 Casserole / Cacerola Ø 24cm - 4,80l  
 1 Deep Casserole / Cacerola honda Ø 20cm - 3,60l  
 1 Frying pan / Sartén Ø 24cm - 2,10l





Exclusive material for legal entities/corporate clients.  
Material exclusivo para clientes persona jurídica.

# Brava Bakelite Baquelita



A feast for the eyes.

With its stainless steel body, the Brava Bakelite cookware features the charm of wood combined with the convenience of heat resistant Bakelite.

Elegance and resistance in the service of taste.

Un banquete para los ojos.

Con el cuerpo de acero inoxidable, las ollas Brava Baquelita traen en encanto de la madera combinado a la practicidad de la baquelita antitérmica.

Elegancia y fuerza al servicio del paladar.





**COOKWARE SET  
BATERÍA DE COCINA  
4 PC./PZAS.**

Ref.	Un.	m <sup>3</sup>	7891116
65180/310	02	0,080	150146

Contents / Contenido:  
 1 Casserole / Cacerola Ø 24cm - 4,80l  
 1 Sauce Pan / Olla Ø 16cm - 1,40l  
 1 Deep Casserole / Cacerola Honda Ø 20cm - 3,60l  
 1 Frying Pan / Sartén Ø 24cm - 2,10l



**COOKWARE SET  
BATERÍA DE COCINA  
4 PC./PZAS.**

Ref.	Un.	m <sup>3</sup>	7891116
65180/510	02	0,074	159743

Contents / Contenido:  
 1 Sauce Pan / Olla Ø 16cm - 1,40l  
 1 Casserole / Cacerola Ø 20cm - 2,90l  
 1 Deep Casserole / Cacerola Honda Ø 20cm - 3,60l  
 1 Frying Pan / Sartén Ø 24cm - 2,10l



**FRYING PAN  
SARTÉN**

	Ref.	Un.	m <sup>3</sup>	7891116
Ø 20cm - 1,30l	62195/205	04	0,025	169773
Ø 24cm - 2,10l	62195/245	04	0,046	159781

Non-Stick Coating  
Revestimiento Antiadherente



**FRYING PAN  
SARTÉN**

	Ref.	Un.	m <sup>3</sup>	7891116
Ø 20cm - 1,30l	62195/207	04	0,025	169759
Ø 24cm - 2,10l	62195/247	04	0,046	169353



# Brava Non-Stick Antiadherente



The Brava line adds new distinguishing features with a non-stick coating.

The smooth touch of wood on the handles and the heat resistant Bakelite ensure greater charm and safety from the stove to the table.

La línea Brava adquiere nuevos diferenciales con el antiadherente.

El toque suave del amaderado en los pomos y la baquelita antitérmica garantizan más encanto y seguridad desde la cocina hasta la mesa.





**COOKWARE SET  
BATERÍA DE COCINA  
4 PC./PZAS.**

Ref.	Un.	m <sup>3</sup>	7891116
65300/310	02	0,080	150139

**Contents / Contenido:**

- 1 Casserole / Cacerola Ø 24cm - 4,80l
- 1 Sauce Pan / Olla Ø 16cm - 1,40l
- 1 Deep Casserole / Cacerola Honda Ø 20cm - 3,60l
- 1 Frying Pan / Sartén Ø 24cm - 2,10l



# Brava



Made entirely of stainless steel with a bold design and high performance, the Brava cookware offers all the benefits of Tramontina's stainless steel combined with the tri-ply base, ensuring quality and efficiency when cooking.

A true success in the kitchen.

Totalmente de acero inoxidable y diseño audaz con alto desempeño, las ollas Brava traen todas las ventajas del acero inoxidable Tramontina aliadas al fondo triple, que garantiza calidad y eficiencia en la cocción.

Un verdadero show en la cocina.





Exclusive material for legal entities/corporate clients.  
Material exclusivo para clientes persona jurídica.





SAUCE PAN  
OLLA

	Ref.	Un.	m <sup>3</sup>	7891116
Ø 16cm - 1,40l	62401/160	04	0,043	138380
Ø 20cm - 2,90l	62401/200	04	0,047	138397



CASSEROLE  
CACEROLA

	Ref.	Un.	m <sup>3</sup>	7891116
Ø 16cm - 1,40l	62403/160	04	0,025	138748
Ø 20cm - 2,90l	62403/200	04	0,045	138403
Ø 24cm - 4,80l	62403/240	04	0,060	138410



DEEP CASEROLE  
CACEROLA HONDA

	Ref.	Un.	m <sup>3</sup>	7891116
Ø 16cm - 1,80l	62404/160	04	0,030	138427
Ø 20cm - 3,60l	62404/200	04	0,045	138434
Ø 24cm - 6,10l	62404/240	04	0,082	138441



STOCK POT  
OLLA ALTA

	Ref.	Un.	m <sup>3</sup>	7891116
Ø 16cm - 2,20l	62405/160	04	0,026	138472
Ø 20cm - 4,60l	62405/200	04	0,060	138458
Ø 24cm - 7,70l	62405/240	04	0,084	138465



FRYING PAN  
SARTÉN

	Ref.	Un.	m <sup>3</sup>	7891116
Ø 24cm - 2,10l	62415/240	04	0,046	138489





**STEAMER  
VAPORERA**

	Ref.	Un.	m <sup>3</sup>	7891116
Ø 20cm - 2,20l	62410/200	04	0,033	139202



**SPAGHETTI POT  
OLLA PARA SPAGHETTI**

	Ref.	Un.	m <sup>3</sup>	7891116
Ø 24cm - 6,10l	62417/240	04	0,082	144718



**PASTA INSERT SET  
JUEGO COZI-PASTA  
2PC./PZAS.**

	Ref.	Un.	m <sup>3</sup>	7891116
Ø 20cm - 4,60l	65400/410	04	0,075	139233
Ø 24cm - 7,70l	65400/400	04	0,101	139226

Contents / Contenido: 65400/410  
1 Stock Pot / Olla Alta Ø 20cm - 4,60l  
1 Pasta Insert / Cozi-pasta Ø 20cm - 4,60l

Contents / Contenido: 65400/400  
1 Stock Pot / Olla Alta Ø 24cm - 7,70l  
1 Pasta Insert / Cozi-pasta Ø 24cm - 8,80l



**COOKWARE SET  
BATERÍA DE COCINA  
3 PC./PZAS.**

	Ref.	Un.	m <sup>3</sup>	7891116
	65400/300	02	0,081	139608

Contents / Contenido:  
1 Sauce Pan / Olla Ø 16cm - 1,40l  
1 Deep Casserole / Cacerola Honda Ø 20cm - 3,60l  
1 Deep Casserole / Cacerola Honda Ø 24cm - 6,10l



**COOKWARE SET  
BATERÍA DE COCINA  
4 PC./PZAS.**

	Ref.	Un.	m <sup>3</sup>	7891116
	65400/310	02	0,081	139615

Contents / Contenido:  
1 Sauce Pan / Olla Ø 16cm - 1,40l  
1 Frying Pan / Sartén Ø 24cm - 2,10l  
1 Deep Casserole / Cacerola Honda Ø 20cm - 3,60l  
1 Casserole / Cacerola Ø 24cm - 4,80l

# Allegra



The Allegra cookware was designed to bring joy to your table. Robust, these products have a tri-ply base and steel body, offering great value.

Available with glass or stainless steel lids, they perform beautifully on the stovetop as well as in the oven.

Las ollas Allegra se crearon para traer felicidad a la mesa. Robustas, cuentan con fondo triple y cuerpo de acero, con excelente costo/beneficio.

Disponibles con tapa de vidrio o acero inoxidable, se lucen tanto en la cocina como en el horno.



**SAUTE PAN  
SARTÉN**

	Ref.	Un.	m <sup>3</sup>	7891116
Ø 20cm - 2,20l	62650/200	04	0,042	061411



**SAUCE PAN  
OLLA**

	Ref.	Un.	m <sup>3</sup>	7891116
Ø 16cm - 1,50l	62651/160	04	0,033	061428
Ø 16cm - 1,50l	62651/164	04	0,033	064665
Ø 16cm - 1,50l	62651/168	04	0,025	088029
Ø 20cm - 2,70l	62651/200	04	0,047	061435
Ø 20cm - 2,70l	62651/204	04	0,047	068182



**CASSEROLE  
CACEROLA**

	Ref.	Un.	m <sup>3</sup>	7891116
Ø 22cm - 3,30l	62653/220	04	0,037	079232
Ø 22cm - 3,30l	62653/224	04	0,037	083345
Ø 22cm - 3,30l	62653/228	04	0,046	104422
Ø 24cm - 4,20l	62653/240	04	0,046	061442
Ø 24cm - 4,20l	62653/244	04	0,046	064672
Ø 24cm - 4,20l	62653/248	04	0,058	088005



**DEEP CASEROLE  
CACEROLA HONDA**

	Ref.	Un.	m <sup>3</sup>	7891116
Ø 16cm - 1,50l	62654/160	04	0,025	061459
Ø 16cm - 1,50l	62654/164	04	0,025	064443
Ø 16cm - 1,50l	62654/168	04	0,018	102046
Ø 18cm - 2,20l	62654/180	04	0,028	083444
Ø 18cm - 2,20l	62654/184	04	0,028	088289
Ø 18cm - 2,20l	62654/188	04	0,028	104439
Ø 20cm - 3,10l	62654/200	04	0,037	061466
Ø 20cm - 3,10l	62654/204	04	0,044	064450
Ø 20cm - 3,10l	62654/208	04	0,037	088012
Ø 22cm - 4,20l	62654/220	04	0,043	079249
Ø 22cm - 4,20l	62654/224	04	0,043	083352
Ø 22cm - 4,20l	62654/228	04	0,046	104446
Ø 24cm - 5,70l	62654/240	04	0,058	061473
Ø 24cm - 5,70l	62654/244	04	0,060	064467
Ø 24cm - 5,70l	62654/248	04	0,060	102053



--0  
**STAINLESS STEEL LID AND  
GIFT BOX | TAPA DE ACERO  
INOXIDABLE Y ESTUCHE DE  
REGALO**



--4  
**GLASS LID AND GIFT BOX  
TAPA DE VIDRIO Y ESTUCHE  
DE REGALO**



--8  
**GLASS LID AND CARTON  
SLEEVE | TAPA DE VIDRIO  
Y EMBALAJE PARA  
AUTOSERVICIO**



Exclusive material for legal entities/corporate clients.  
Material exclusivo para clientes persona jurídica.





STOCK POT  
OLLA ALTA

	Ref.	Un.	m <sup>3</sup>	7891116
Ø 18cm - 3,00l	62655/180	04	0,035	083468
Ø 18cm - 3,00l	62655/184	04	0,035	088296
Ø 18cm - 3,00l	62655/188	04	0,043	104453
Ø 20cm - 4,40l	62655/200	04	0,056	061480
Ø 20cm - 4,40l	62655/204	04	0,056	064474
Ø 20cm - 4,40l	62655/208	04	0,060	102060
Ø 22cm - 5,50l	62655/220	04	0,055	079256
Ø 22cm - 5,50l	62655/224	04	0,055	083369
Ø 22cm - 5,50l	62655/228	04	0,082	104460
Ø 24cm - 7,50l	62655/240	04	0,083	066041
Ø 24cm - 7,50l	62655/244	04	0,083	068793
Ø 24cm - 7,50l	62655/248	04	0,082	102077



DEEP SAUCE PAN  
OLLA HONDA

	Ref.	Un.	m <sup>3</sup>	7891116
Ø 16cm - 2,10l	62657/160	04	0,040	061497
Ø 16cm - 2,10l	62657/164	04	0,048	064481
Ø 16cm - 2,10l	62657/168	04	0,040	104477



STEAMER  
VAPORERA

	Ref.	Un.	m <sup>3</sup>	7891116
Ø 20cm - 2,20l	62660/200	04	0,027	061503



SPAGHETTI POT  
OLLA PARA SPAGHETTI

	Ref.	Un.	m <sup>3</sup>	7891116
Ø 20cm - 4,40l	62667/203	04	0,053	105436
Ø 22cm - 5,50l	62667/223	02	0,037	103449



COLANDER  
COLADOR PARA PASTA  
SERVICE

	Ref.	Un.	m <sup>3</sup>	7891116
Ø 20cm - 2,35l	61422/201*	04	0,017	048634
Ø 25cm - 4,75l	61422/250	04	0,059	048641
Ø 25cm - 4,75l	61422/251*	04	0,020	048658

\* No Packaging / Sin Embalaje



		MILK BOILER HERVIDOR			
		Ref.	Un.	m <sup>3</sup>	7891116
Ø 12cm - 1,40l		62934/120	04	0,020	079270



		MILK BOILER HERVIDOR			
		Ref.	Un.	m <sup>3</sup>	7891116
Ø 12cm - 1,40l		62664/120	04	0,020	062708
Ø 12cm - 1,40l		62664/121*	04	0,017	073766

\*No packaging / Sin embalaje



		MILK BOILER - TRIPLE BOTTOM HERVIDOR - CON FONDO TRIPLE			
		Ref.	Un.	m <sup>3</sup>	7891116
Ø 14cm - 2,00l		62932/140	04	0,030	101452



**STEAMER SET  
OLLA VAPORERA  
2 PC./PZAS.**

		Ref.	Un.	m <sup>3</sup>	7891116
		65650/050**	04	0,035	063279

Contents / Contenido:  
1 Deep Casserole / Cacerola Honda Ø 16cm -1,50l  
1 Steamer / Vaporera Ø 16cm - 1,60l



Exclusive material for legal entities/corporate clients.  
Material exclusivo para clientes persona jurídica.



**PASTA INSERT SET  
JUEGO COZI-PASTA  
2 PC./PZAS.**

Ref.	Un.	m <sup>3</sup>	7891116
65650/060**	04	0,059	063392

Contents / Contenido:  
1 Stock Pot / Olla Alta Ø 20cm - 4,40l  
1 Pasta Insert / Cozi-Pasta Ø 20cm - 4,60l



**MULTI COOKER  
JUEGO MULTIUSO  
3 PC./PZAS.**

Ref.	Un.	m <sup>3</sup>	7891116
65650/070**	04	0,087	064955

Contents / Contenido:  
1 Stock Pot / Olla Alta Ø 20cm - 4,40l  
1 Steamer / Vaporera Ø 20cm - 2,20l  
1 Pasta Insert / Cozi-Pasta Ø 20cm - 4,60l



**COOKWARE SET  
BATERÍA DE COCINA  
3 PC./PZAS.**

Ref.	Un.	m <sup>3</sup>	7891116
65660/484*	02	0,075	086308

Contents / Contenido:  
1 Sauce Pan / Olla Ø 16cm - 1,50l  
1 Deep Casserole / Cacerola Honda Ø 20cm - 3,10l  
1 Deep Casserole / Cacerola Honda Ø 24cm - 5,70l





**COOKWARE SET  
BATERÍA DE COCINA  
3 PC./PZAS.**

Ref.	Un.	m <sup>3</sup>	7891116
*65660/694	02	0,056	101896

Contents / Contenido:  
 1 Sauce Pan / Olla Ø 16cm - 1,50l  
 1 Frying Pan / Sartén Ø 20cm - 1,30l  
 1 Deep Casserole / Cacerola Honda Ø 20cm - 3,10l



**COOKWARE SET  
BATERÍA DE COCINA  
3 PC./PZAS.**

Ref.	Un.	m <sup>3</sup>	7891116
*65660/714	02	0,074	102817

Contents / Contenido:  
 1 Sauce Pan / Olla Ø 16cm - 1,50l  
 1 Deep Casserole / Cacerola Honda Ø 20cm - 3,10l  
 1 Casserole / Cacerola Ø 24cm - 4,20l



**COOKWARE SET  
BATERÍA DE COCINA  
4 PC./PZAS.**

Ref.	Un.	m <sup>3</sup>	7891116
*65650/324	02	0,075	072370

Contents / Contenido:  
 1 Sauce Pan / Olla Ø 16cm - 1,50l  
 1 Frying Pan / Sartén Ø 20cm - 1,30l  
 1 Deep Casserole / Cacerola Honda Ø 20cm - 3,10l  
 1 Casserole / Cacerola Ø 24cm - 4,20l



**COOKWARE SET  
BATERÍA DE COCINA  
4 PC./PZAS.**

Ref.	Un.	m <sup>3</sup>	7891116
**65650/326	02	0,067	073179

Contents / Contenido:  
 1 Sauce Pan / Olla Ø 16cm - 1,50l  
 1 Frying Pan / Sartén Ø 20cm - 1,30l  
 1 Deep Casserole / Cacerola Honda Ø 20cm - 3,10l  
 1 Casserole / Cacerola Ø 24cm - 4,20l

\* Glass Lid / Tapa de Vidrio  
 \*\* Stainless Steel Lid / Tapa de Acero Inoxidable

Exclusive material for legal entities/corporate clients.  
 Material exclusivo para clientes persona jurídica.



**COOKWARE SET  
BATERÍA DE COCINA  
5 PC./PZAS.**

Ref.	Un.	m <sup>3</sup>	7891116
*65660/794	02	0,075	103173

Contents / Contenido:  
 1 Sauce Pan / Olla Ø 16cm - 1,50l  
 1 Deep Casserole / Cacerola Honda Ø 16cm - 1,50l  
 1 Deep Casserole / Cacerola Honda Ø 20cm - 3,10l  
 1 Deep Casserole / Cacerola Honda Ø 24cm - 5,70l  
 1 Casserole / Cacerola Ø 22cm - 3,30l



**COOKWARE UNIQUE PRICE  
OLLAS PRECIO UNICO  
12 PC./PZAS.**

Ref.	Un.	m <sup>3</sup>	7891116
65660/164**	12	0,128	156575

Contents / Contenido:  
 04 - Casserole / Cacerola Ø 22cm - 3,30l  
 04 - Casserole / Cacerola Ø 24cm - 4,20l  
 04 - Deep Casserole / Cacerola Honda Ø 22cm - 4,20l

Price per unit | Precio por unidad



**FRYING PAN  
SARTÉN**

	Ref.	Un.	m <sup>3</sup>	7891116
Ø 20cm - 1,30l	62666/200	04	0,025	068991
Ø 24cm - 2,10l	62666/240	04	0,046	108277

# VENTURA



	WOK			
	Ref.	Un.	m <sup>3</sup>	7891116
Ø 34cm - 5,70l	62378/340	02	0,042	089392
Ø 34cm - 5,70l	62378/348	02	0,040	109908



	FRYING PAN   SARTÉN			
	Ref.	Un.	m <sup>3</sup>	7891116
Ø 20cm - 1,30l	62376/200	04	0,025	089002
Ø 24cm - 2,10l	62376/240	04	0,046	108307



	FRYING PAN   SARTÉN			
	Ref.	Un.	m <sup>3</sup>	7891116
Ø 20cm - 1,30l	62376/204	04	0,025	115909
Ø 24cm - 2,10l	62376/244	04	0,046	115923



	FRYING PAN   SARTÉN			
	Ref.	Un.	m <sup>3</sup>	7891116
Ø 20cm - 1,30l	62376/207	04	0,025	115916
Ø 24cm - 2,10l	62376/247	04	0,046	115930

# Brava

## Pressure Cooker

### Olla a Presión



TecnoHeat

With its sophisticated design, the Brava pressure cooker highlights the kitchen's character and ensures peace of mind when using.

Safety devices avoid overloading and a pressure pin helps you monitor the cooking. Easy to close and simple to use.

Con diseño sofisticado, la olla a presión Brava realza la personalidad de la cocina y garantiza tranquilidad en el uso.

Mecanismos de seguridad evitan sobrecarga y un eje de presión ayuda a controlar la cocción. Fácil de cerrar y sencillo de usar.





PRESSURE COOKER  
 OLLA A PRESIÓN

NEW RELEASE  
 LANZAMIENTO

	Ref.	Un.	m <sup>3</sup>	7891116
Ø 20cm - 4,50l	62416/200	02	0,047	154885
Ø 22cm - 6,00l	62416/220	02	0,067	172858



# Allegra Pressure Cooker Olla a Presión



The Allegra pressure cooker is the right choice for those who enjoy being creative in the kitchen.

Equipped with several safety devices, it provides total peace of mind when cooking, and also features heat resistant Bakelite handles that guarantee comfort and prevent burns.

La olla de presión Allegra es la opción de los que les gusta crear en la cocina.

Equipada con varios dispositivos de seguridad, propicia tranquilidad total en la cocina y también trae pomos de baquelita antitérmica, garantizando comodidad y evitando quemaduras.



PRESSURE COOKER  
OLLA A PRESIÓN

	Ref.	Un.	m <sup>3</sup>	7891116
Ø 22cm - 6,00l	62676/220*	04	0,116	147788

\* Imported Product / Producto Importado



# Solar Pressure Cooker Olla a Presión



Safety, durability and a touch of charm: this is the Solar pressure cooker.

This line features five safety devices, as well as the durability of stainless steel with a distinctive design in vibrant colors. For doing great in every kitchen.

Seguridad, durabilidad y un toque de encanto: esa es la olla a presión Solar.

La línea trae cinco mecanismos de seguridad, además de la durabilidad del acero inoxidable en un diseño diferenciado, con colores vibrantes. Para lucirse en todas las cocinas.





**PRESSURE COOKER  
OLLA A PRESIÓN**

	Ref.	Un.	m <sup>3</sup>	7891116
Ø 22cm - 3,00l	62511/223	02	0,056	101346
Ø 22cm - 4,50l	62513/222	02	0,067	070512
Ø 22cm - 6,00l	62516/222	02	0,067	070529
Ø 22cm - 4,50l	62513/223*	02	0,067	079799
Ø 22cm - 6,00l	62516/223*	02	0,067	079805

\*Models 62513/223 and 62516/223 do not come with Steam Basket or accessories support.

\*Los modelos 62513/223 y 62516/223 no vienen con Vaporera ni base de apoyo para accesorio.



**PRESSURE COOKER  
OLLA A PRESIÓN**

	Ref.	Un.	m <sup>3</sup>	7891116
Ø 22cm - 4,50l	62513/226	02	0,067	101391
Ø 22cm - 6,00l	62516/226	02	0,067	101407

Don't come with Steam Basket or accessories support.  
No vienen con Vaporera ni base de apoyo para accesorio.



# Roasting pans

# Asaderas



From the oven to your table, without any stops in between.

Made of stainless steel, Tramontina's line of roasting pans ensures convenience in cooking, elegance in serving and speed in cleaning.

With a polished finish, these pans do a beautiful job for much longer in your kitchen.

Del horno a la mesa, sin escalas.

Fabricado en acero inoxidable, la línea de asaderas Tramontina garantiza practicidad en la cocción, elegancia al servir y rapidez en el momento de limpiar.

Con terminación pulida, se luce mucho más tiempo en la cocina.



**BAKE & ROAST PAN  
ASADERA  
COSMOS**

	Ref.	Un.	m <sup>3</sup>	7891116
294 x 192mm	61310/301*	08	0,017	020173
340 x 222mm	61310/341*	08	0,024	186510
385 x 251mm	61310/391*	08	0,024	020159
430 x 282mm	61310/431*	08	0,035	186688
476 x 311mm	61310/481*	08	0,061	020166
520 x 340mm	61310/521*	08	0,049	018675

**BAKE & ROAST PAN SET  
JUEGO DE ASADERAS  
3 PC./PZAS.  
COSMOS**

	Ref.	Un.	m <sup>3</sup>	7891116
	64310/400	05	0,045	058701

**Contents / Contenido:**

- 1 Bake & Roast Pan / Fuente para Hornear 294 x 192mm
- 1 Bake & Roast Pan / Fuente para Hornear 340 x 222mm
- 1 Bake & Roast Pan / Fuente para Hornear 385 x 251mm



**BAKE & ROAST PAN WITH GLASS LID  
ASADERA CON TAPA DE VIDRIO  
COSMOS**

	Ref.	Un.	m <sup>3</sup>	7891116
340 x 222mm	61315/344	06	0,033	061244
385 x 251mm	61315/394	06	0,059	056219
430 x 282mm	61315/434	06	0,059	061183

**LID | TAPA**

	Ref.	Un.	m <sup>3</sup>	7891116
	62718/294	04	0,017	062395
	62718/334	04	0,024	600009
	62718/374	04	0,024	062388

\* No Packaging / Sin Embalaje





Exclusive material for legal entities/corporate clients.  
Material exclusivo para clientes persona jurídica.





**SERVICE SET**  
**JUEGO PARA ASAR Y SERVIR**  
**4 PC./PZAS.**  
**COSMOS**

Ref.	Un.	m <sup>3</sup>	7891116
64310/250	06	0,092	118078

Contents / Contenido:  
 1 Bake & Roast Pan / Asadera 340 x 222mm  
 1 Bake & Roast Pan / Asadera 385 x 251mm  
 1 Serving Spoon / Cuchara para Servir  
 1 Spaghetti Tong / Pinza para Pasta



**SERVICE SET**  
**JUEGO PARA ASAR Y SERVIR**  
**3 PC./PZAS.**  
**COSMOS**

Ref.	Un.	m <sup>3</sup>	7891116
64310/114	06	0,059	062371

Contents / Contenido:  
 1 Bake & Roast Pan with Glass Lid / Asadera con Tapa de Vidrio 385 x 251mm  
 1 Serving Spoon / Cuchara para Servir  
 1 Spaghetti Tong / Pinza para Pasta



**SERVICE SET**  
**JUEGO PARA ASAR Y SERVIR**  
**4 PC./PZAS.**  
**COSMOS**

Ref.	Un.	m <sup>3</sup>	7891116
64310/150	04	0,077	070390

Contents / Contenido:  
 1 Bake & Roast Pan with Glass Lid / Asadera con Tapa de Vidrio - 340 x 222mm  
 1 Bake & Roast Pan with Glass Lid / Asadera con Tapa de Vidrio - 385 x 251mm  
 1 Serving Spoon / Cuchara para Servir  
 1 Spaghetti Tong / Pinza para Pasta



**BAKE & ROAST WITH GRILL**  
**FUENTE PARA HORNEAR CON PARRILLA**  
**SERVICE**

	Ref.	Un.	m <sup>3</sup>	7891116
345 x 285 x 60mm	61409/340	05	0,049	005477
390 x 330 x 62mm	61409/380	05	0,071	005484



**SERVING SET**  
**JUEGO PARA ASAR Y SERVIR**  
**6 PC./PZAS.**  
**COSMOS**

Ref.	Un.	m <sup>3</sup>	7891116
64310/260	03	0,092	118085

Contents / Contenido:  
 1 Bake & Roast Pan / Asadera 294 x 192mm  
 1 Baking & Roast Pan Tempered Glass Lid /  
 Asadera con Tapa de Vidrio Templado 340 x 222mm  
 1 Mixing bowl / Recipiente Redondo Ø 24cm - 2,80l  
 1 Serving Spoon / Cuchara para Servir  
 1 Carving Fork / Tenedor Trinchant  
 1 Spaghetti Tong / Pinza para Pasta



**SERVING SET**  
**JUEGO PARA ASAR Y SERVIR**  
**7 PC./PZAS.**  
**COSMOS**

Ref.	Un.	m <sup>3</sup>	7891116
64310/080	03	0,145	061404

Contents / Contenido:  
 1 Baking & Roast Pan / Asadera 340x222mm  
 1 Baking & Roast Pan with Tempered Glass Lid /  
 Asadera con Tapa de Vidrio Templada 385x251mm  
 1 Mixing bowl with tempered glass lid / Recipiente  
 con tapa de vidrio templado Ø 24cm - 2,80l  
 1 Napkin Holder / Servilletero  
 1 Spaghetti Tong / Pinza para Pasta  
 1 Salad Spoon / Cuchara para Ensalada  
 1 Salad Fork / Tenedor para Ensalada



# PIZZA



PIZZA PAN  
ASADERA DE PIZZA

	Ref.	Un.	m <sup>3</sup>	7891116
Ø 30cm	61731/300	12	0,007	080566
Ø 35cm	61731/350	12	0,010	078815
Ø 40cm	61731/400	12	0,013	078822



PIZZA PAN  
ASADERA DE PIZZA

	Ref.	Un.	m <sup>3</sup>	7891116
Ø 30cm	61744/300	12	0,007	080573



PIZZA SET  
JUEGO PARA PIZZA  
14 PC./PZAS.

	Ref.	Un.	m <sup>3</sup>	7891116
Laguna	66906/680	05	0,055	166529

Contents / Contenido:  
 6 Pizza knives / Cuchillos para pizza  
 6 Pizza forks / Tenedores para pizza  
 1 Pizza spatula / Espátula para pizza  
 1 Pizza cutter / Cortador para pizza



PIZZA PAN  
ASADERA DE PIZZA  
6 PC./PZAS.

	Ref.	Un.	m <sup>3</sup>	7891116
Ø 35cm	61731/355	06	0,092	105993

6 units per display box / Caja display con 6 unidades



# TABLEWARE CUBIERTOS

---



Exclusive material for legal entities/corporate clients.  
Material exclusivo para clientes persona jurídica.



## QUALITY AND ELEGANCE

# DOING WHAT YOU DO BEST AT THE TABLE

Comfort at the touch of a hand. Well-being within sight. Refined, convenient, contemporary or classic, Tramontina's flatware brings about the wonderful feeling of a table set with love and style.

There are different flatware sets that highlight the pleasure of a good meal, from breakfast to dinner, and that make things beautiful at the best moments of the day.

## CALIDAD Y ELEGANCIA

# LUCIÉNDOSE EN LA MESA

La comodidad al alcance de las manos. El bienestar al alcance de los ojos. Finos, prácticos, modernos o clásicos, los cubiertos Tramontina traen a luz las mejores sensaciones de una mesa armada con cariño y mucho estilo.

Son diversos modelos de juegos de cubiertos que destacan el placer de una buena comida - desde el desayuno hasta la cena - y se lucen en los mejores momentos del día.





**ALL TRAMONTINA  
STAINLESS STEEL  
CUTLERY:  
!TODOS LOS CUBIERTOS  
DE ACERO INOXIDABLE  
TRAMONTINA:**



## **ERGONOMIC SON ERGONÓMICOS**

Items more comfortable to handle due to their design. The items are a perfect size and have carefully rounded edges, and the forks have polished tines with rounded edges for more comfortable handling. The handles sit perfectly in your palm.

El diseño de las piezas es el responsable por la comodidad en el uso. Las piezas tienen el tamaño ideal para la boca, tienen bordes cuidadosamente redondeados y, en los tenedores, los dientes son pulidos en la parte interna para mayor bienestar del usuario. Los mangos se adaptan muy bien a la palma de la mano.

## **THEY HAVE VERY HIGH QUALITY BLADES.**

## **TIENEN LÁMINAS DE ALTÍSIMA CALIDAD**

The knives have tempered blades, which ensures a longer-lasting edge and greater resistance against corrosion. Due to these features, they don't scratch the dishes.

Las láminas reciben un tratamiento térmico, que garantiza el corte de gran durabilidad y mayor resistencia a la corrosión. Además, no arañan la porcelana.

## **WITH EXCLUSIVE DESIGN**

## **POSEEN DESIGN EXCLUSIVO**

There are 24 different lines, each line with its particularities and details that enhance and enrich the pieces.

Son 24 líneas diferentes, cada una con sus particularidades y detalles que valorizan y enriquecen las piezas.







# menu TABLEWARE / CUBIERTOS

63979 • **CANNES** • 164



63915 • **SEVILHA** • 174



63929 • **RENASCENÇA** • 166



63917 • **MÔNACO** • 176

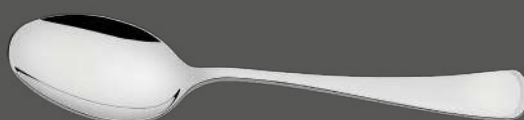

63928 • **CLASSIC** • 168



63932 • **ITALY** • 178



63924 • **VICENZA** • 170



63934 • **BERLIN** • 180



63925 • **FIRENZE** • 172



63986 • **ZURIQUE** • 182

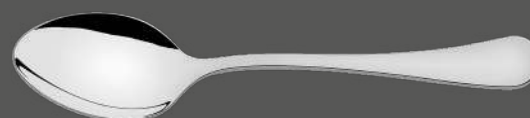

63982 • **SATRI** • 184





63985 • **OSLO** • 186



63950 • **COSMOS** • 198

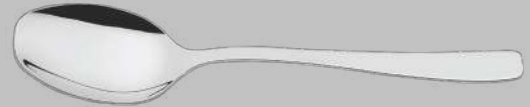

63912 • **SONATA** • 188



63903 • **ANGRA** • 200



63965 • **CONTINENTAL** • 190



63906 • **LAGUNA** • 202



63962 • **PACIFIC** • 192



63902 • **MARESIAS** • 204

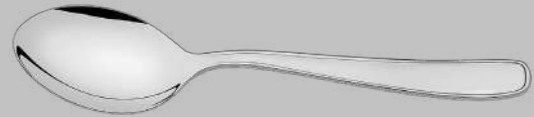

63960 • **AMAZONAS** • 194



63945 • **HAVANA** • 206



63940 • **ATHENAS** • 196



63905 • **HAVAIÍ** • 208



63989 • **BAGUETTE** • 210





















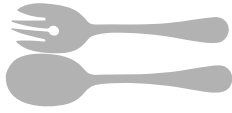



63979

# Cannes

	010   Table Spoon Cuchara de Mesa	mm	Un.	m <sup>3</sup>			
		4,00	60	0,005			
	020   Table Fork Tenedor de Mesa	mm	Un.	m <sup>3</sup>			
		4,00	60	0,005			
	040   Dessert Spoon Cuchara para Postre	mm	Un.	m <sup>3</sup>			
		3,00	60	0,005			
	050   Dessert Fork Tenedor para Postre	mm	Un.	m <sup>3</sup>			
		3,00	60	0,003			
	070   Tea Spoon Cuchara para Té	mm	Un.	m <sup>3</sup>			
		2,50	60	0,001			
	080   Coffee Spoon Cuchara para Café	mm	Un.	m <sup>3</sup>			
		2,50	60	0,002			
	090   Soup Ladle Cazo para Sopa	mm	Un.	m <sup>3</sup>			
		3,00	12	0,007			
	100   Serving Spoon Cuchara para Servir	mm	Un.	m <sup>3</sup>			
		4,00	12	0,004			
	110   Sugar Spoon Cuchara para Azúcar	mm	Un.	m <sup>3</sup>			
		2,50	60	0,002			
	120   Salad Server Juego para Servir Ensalada	mm	Un.	m <sup>3</sup>			
		4,00	12	0,010			
	140   Cake Fork Tenedor para Pastel	mm	Un.	m <sup>3</sup>			
		2,50	60	0,002			
	150   Cake Server Espátula para Pastel	mm	Un.	m <sup>3</sup>			
		4,00	12	0,010			
	250   Fish Fork Tenedor para Pescado	mm	Un.	m <sup>3</sup>			
		4,00	60	0,003			
	260   Fish Knife Cuchillo para Pescado	mm	Un.	m <sup>3</sup>			
		4,00	60	0,005			
	830   Table Knife (Solid Handle) Cuchillo de Mesa Forjado	mm	Un.	m <sup>3</sup>			
		10,00	60	0,007			
	860   Dessert Knife (Solid Handle) Cuchillo para Postre Forjado	mm	Un.	m <sup>3</sup>			
		9,80	60	0,007			
	980   Steak Knife (Solid Handle) Cuchillo para Asado Forjado	mm	Un.	m <sup>3</sup>			
		10,00	60	0,007			





















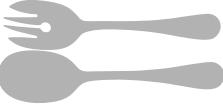





63929

# Renascença

	010   Table Spoon Cuchara de Mesa	mm	Un.	m <sup>3</sup>	
		3,00	60	0,006	
	020   Table Fork Tenedor de Mesa	mm	Un.	m <sup>3</sup>	
		3,00	60	0,005	
	030   Table Knife * Cuchillo de Mesa	mm	Un.	m <sup>3</sup>	
		11,00	60	0,007	
	040   Dessert Spoon Cuchara para Postre	mm	Un.	m <sup>3</sup>	
		2,75	60	0,006	
	050   Dessert Fork Tenedor para Postre	mm	Un.	m <sup>3</sup>	
		2,75	60	0,003	
	060   Dessert Knife* Cuchillo para Postre	mm	Un.	m <sup>3</sup>	
		10,00	60	0,007	
	070   Tea Spoon Cuchara para Té	mm	Un.	m <sup>3</sup>	
		2,50	60	0,002	
	080   Coffee Spoon Cuchara para Café	mm	Un.	m <sup>3</sup>	
		2,25	60	0,002	
	090   Soup Ladle Cazo para Sopa	mm	Un.	m <sup>3</sup>	
		3,00	12	0,009	
	100   Serving Spoon Cuchara para Servir	mm	Un.	m <sup>3</sup>	
		3,00	12	0,004	
	110   Sugar Spoon Cuchara para Azúcar	mm	Un.	m <sup>3</sup>	
		2,50	60	0,002	
	120   Salad Server Juego para Servir Ensalada	mm	Un.	m <sup>3</sup>	
		3,00	12	0,012	
	140   Cake Fork Tenedor para Pastel	mm	Un.	m <sup>3</sup>	
		2,50	60	0,002	
	150   Cake Server Espátula para Pastel	mm	Un.	m <sup>3</sup>	
		3,00	12	0,012	
	180   Steak Knife * Cuchillo para Asado	mm	Un.	m <sup>3</sup>	
		11,00	60	0,007	
	210   Sauce Ladle Cazo de Salsa Pequeño	mm	Un.	m <sup>3</sup>	
		3,00	12	0,003	
	240   Butter Spreader Espátula para Matenquilla	mm	Un.	m <sup>3</sup>	
		2,50	60	0,002	
	250   Fish Fork Tenedor para Pescado	mm	Un.	m <sup>3</sup>	
		3,00	60	0,003	
	260   Fish Knife Cuchillo para Pescado	mm	Un.	m <sup>3</sup>	
		3,00	60	0,006	
	270   Fish Server Juego para Servir Pescado	mm	Un.	m <sup>3</sup>	
		3,00	12	0,007	
	280   Soup Spoon Cuchara para sopa	mm	Un.	m <sup>3</sup>	
		2,75	60	0,006	
	810   Fruit Knife * Cuchillo para Fruta	mm	Un.	m <sup>3</sup>	
		5,70	60	0,003	

\*Hollow Handle / Mango Hueco





































63924

# Vicenza























	010   Table Spoon Cuchara de Mesa mm Un. m³ 3,00 60 0,006		190   Ladle Cazo Mediano mm Un. m³ 3,00 12 0,007
	020   Table Fork Tenedor de Mesa mm Un. m³ 3,00 60 0,005		210   Sauce Ladle Cazo de Salsa Pequeño mm Un. m³ 3,00 12 0,003
	040   Dessert Spoon Cuchara para Postre mm Un. m³ 2,75 60 0,006		240   Butter Spreader Espátula para Mantequilla mm Un. m³ 2,50 60 0,002
	050   Dessert Fork Tenedor para Postre mm Un. m³ 2,75 60 0,003		250   Fish Fork Tenedor para Pescado mm Un. m³ 3,00 60 0,003
	070   Tea Spoon Cuchara para Té mm Un. m³ 2,50 60 0,002		260   Fish Knife Cuchillo para Pescado mm Un. m³ 3,00 60 0,005
	080   Coffee Spoon Cuchara para café mm Un. m³ 2,25 60 0,002		270   Fish Server Juego para Servir Pescado mm Un. m³ 3,00 12 0,007
	090   Soup Ladle Cazo para Sopa mm Un. m³ 3,00 12 0,009		280   Soup Spoon Cuchara para Sopa mm Un. m³ 2,75 60 0,006
	100   Serving Spoon Cuchara para Servir mm Un. m³ 3,00 12 0,004		290   Special tea Spoon Cuchara Mediana mm Un. m³ 2,50 60 0,003
	110   Sugar Spoon Cuchara para Azúcar mm Un. m³ 2,50 60 0,002		810   Fruit Knife Cuchillo para Fruta mm Un. m³ 6,00 60 0,007
	120   Salad Server Juego para Servir Ensalada mm Un. m³ 3,00 12 0,012		830   Table Knife (Solid Handle) Cuchillo de Mesa Forjado mm Un. m³ 8,90 60 0,007
	140   Cake Fork Tenedor para Pastel mm Un. m³ 2,50 60 0,002		860   Dessert Knife (Solid Handle) Cuchillo para Postre Forjado mm Un. m³ 9,00 60 0,007
	150   Cake Server Espátula para Pastel mm Un. m³ 3,00 12 0,012		980   Steak Knife (Solid Handle) Cuchillo para Asado Forjado mm Un. m³ 8,90 60 0,007





63925

# Firenze

	010   Table Spoon Cuchara de Mesa mm Un. m <sup>3</sup> 3,00 60 0,006		190   Ladle Cazo Mediano mm Un. m <sup>3</sup> 3,00 12 0,007
	020   Table Fork Tenedor de Mesa mm Un. m <sup>3</sup> 3,00 60 0,005		210   Sauce Ladle Cazo de Salsa Pequeño mm Un. m <sup>3</sup> 3,00 12 0,003
	040   Dessert Spoon Cuchara para Postre mm Un. m <sup>3</sup> 2,75 60 0,006		240   Butter Spreader Espátula para Mantequilla mm Un. m <sup>3</sup> 2,50 60 0,002
	050   Dessert Fork Tenedor para Postre mm Un. m <sup>3</sup> 2,75 60 0,003		250   Fish Fork Tenedor para Pescado mm Un. m <sup>3</sup> 3,00 60 0,003
	070   Tea Spoon Cuchara para Té mm Un. m <sup>3</sup> 2,50 60 0,002		260   Fish Knife Cuchillo para Pescado mm Un. m <sup>3</sup> 3,00 60 0,005
	080   Coffee Spoon Cuchara para café mm Un. m <sup>3</sup> 2,25 60 0,002		270   Fish Server Juego para Servir Pescado mm Un. m <sup>3</sup> 3,00 12 0,007
	090   Soup Ladle Cazo para Sopa mm Un. m <sup>3</sup> 3,00 12 0,009		280   Soup Spoon Cuchara para Sopa mm Un. m <sup>3</sup> 2,75 60 0,006
	100   Serving Spoon Cuchara para Servir mm Un. m <sup>3</sup> 3,00 12 0,004		290   Special tea Spoon Cuchara Mediana mm Un. m <sup>3</sup> 2,50 60 0,003
	110   Sugar Spoon Cuchara para Azúcar mm Un. m <sup>3</sup> 2,50 60 0,002		830   Table Knife (Solid Handle) Cuchillo de Mesa Forjado mm Un. m <sup>3</sup> 8,90 60 0,007
	120   Salad Server Juego para Servir Ensalada mm Un. m <sup>3</sup> 3,00 12 0,012		860   Dessert Knife (Solid Handle) Cuchillo para Postre Forjado mm Un. m <sup>3</sup> 9,00 60 0,007
	140   Cake Fork Tenedor para Pastel mm Un. m <sup>3</sup> 2,50 60 0,002		980   Steak Knife (Solid Handle) Cuchillo para Asado Forjado mm Un. m <sup>3</sup> 8,90 60 0,007
	150   Cake Server Espátula para Pastel mm Un. m <sup>3</sup> 3,00 12 0,012		





























63915



























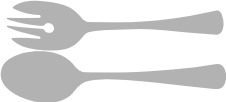

# Sevilha

	010   Table Spoon Cuchara de Mesa	mm	Un.	m <sup>3</sup>
		2,50	60	0,006
	020   Table Fork Tenedor de Mesa	mm	Un.	m <sup>3</sup>
		2,50	60	0,005
	040   Dessert Spoon Cuchara para Postre	mm	Un.	m <sup>3</sup>
		2,25	60	0,006
	050   Dessert Fork Tenedor para Postre	mm	Un.	m <sup>3</sup>
		2,25	60	0,003
	070   Tea Spoon Cuchara para Té	mm	Un.	m <sup>3</sup>
		2,00	60	0,002
	080   Coffee Spoon Cuchara para Café	mm	Un.	m <sup>3</sup>
		2,00	60	0,002
	090   Soup Ladle Cazo para Sopa	mm	Un.	m <sup>3</sup>
		2,50	12	0,009
	100   Serving Spoon Cuchara para Servir	mm	Un.	m <sup>3</sup>
		2,50	12	0,004
	110   Sugar Spoon Cuchara para Azúcar	mm	Un.	m <sup>3</sup>
		2,00	60	0,002
	120   Salad Server Juego para Servir Ensalada	mm	Un.	m <sup>3</sup>
		2,50	12	0,012
	140   Cake Fork Tenedor para Pastel	mm	Un.	m <sup>3</sup>
		2,00	60	0,002
	150   Cake Server Espátula para Pastel	mm	Un.	m <sup>3</sup>
		2,50	12	0,009
	170   Carving set Juego de cubiertos Trinchantes	mm	Un.	m <sup>3</sup>
		•2,50	12	0,007
		••11,00		
	190   Ladle Cazo Mediano	mm	Un.	m <sup>3</sup>
		2,50	12	0,007
	210   Sauce Ladle Cazo de Salsa Pequeño	mm	Un.	m <sup>3</sup>
		2,50	12	0,003
	240   Butter Spreader Espátula para Mantequilla	mm	Un.	m <sup>3</sup>
		2,00	60	0,002
	250   Fish Fork Tenedor para Pescado	mm	Un.	m <sup>3</sup>
		2,50	60	0,003
	260   Fish Knife Cuchillo para Pescado	mm	Un.	m <sup>3</sup>
		2,50	60	0,002
	280   Soup Spoon Cuchara para Sopa	mm	Un.	m <sup>3</sup>
		2,25	60	0,006
	290   Special tea Spoon Cuchara Mediana	mm	Un.	m <sup>3</sup>
		2,00	60	0,006
	810   Fruit Knife Cuchillo para Fruta	mm	Un.	m <sup>3</sup>
		6,00	60	0,003
	837   Table Knife (Solid Handle) Cuchillo de Mesa Forjado	mm	Un.	m <sup>3</sup>
		5,70	60	0,007
	987   Steak Knife (Solid Handle) Cuchillo para Asado Forjado	mm	Un.	m <sup>3</sup>
		6,00	60	0,007



63917

# Mônaco

	010   Table Spoon Cuchara de Mesa	mm Un. m <sup>3</sup>			200   Ice Drink Spoon Cuchara para refresco	mm Un. m <sup>3</sup>	
		2,50 60 0,006				2,25 60 0,006	
	020   Table Fork Tenedor de Mesa	mm Un. m <sup>3</sup>			210   Sauce Ladle Cazo de Salsa Pequeña	mm Un. m <sup>3</sup>	
		2,50 60 0,005				2,50 12 0,003	
	040   Dessert Spoon Cuchara para Postre	mm Un. m <sup>3</sup>			240   Butter Spreader Espátula para Mantequilla	mm Un. m <sup>3</sup>	
		2,25 60 0,006				2,00 60 0,002	
	050   Dessert Fork Tenedor para Postre	mm Un. m <sup>3</sup>			250   Fish Fork Tenedor para Pescado	mm Un. m <sup>3</sup>	
		2,25 60 0,003				2,50 60 0,003	
	070   Tea Spoon Cuchara para Té	mm Un. m <sup>3</sup>			260   Fish Knife Cuchillo para Pescado	mm Un. m <sup>3</sup>	
		2,00 60 0,002				2,25 60 0,003	
	080   Coffee Spoon Cuchara para Café	mm Un. m <sup>3</sup>			270   Fish Server Juego para Servir Pescado	mm Un. m <sup>3</sup>	
		2,00 60 0,002				2,50 12 0,009	
	090   Soup Ladle Cazo para Sopa	mm Un. m <sup>3</sup>			280   Soup Spoon Cuchara para Sopa	mm Un. m <sup>3</sup>	
		2,50 12 0,009				2,25 60 0,006	
	100   Serving Spoon Cuchara para Servir	mm Un. m <sup>3</sup>			290   Special Tea Spoon Cuchara Mediana	mm Un. m <sup>3</sup>	
		2,50 12 0,004				2,00 60 0,006	
	110   Sugar Spoon Cuchara para Azúcar	mm Un. m <sup>3</sup>			830   Table Knife (Solid Handle) Cuchillo de Mesa Forjado	mm Un. m <sup>3</sup>	
		2,00 60 0,002				9,00 60 0,006	
	120   Salad Server Juego para Servir Ensalada	mm Un. m <sup>3</sup>			837   Table Knife (Solid Handle) Cuchillo de Mesa Forjado	mm Un. m <sup>3</sup>	
		2,50 12 0,012				6,00 60 0,007	
	140   Cake Fork Tenedor para Pastel	mm Un. m <sup>3</sup>			860   Dessert Knife (Solid Handle) Cuchillo para Postre Forjado	mm Un. m <sup>3</sup>	
		2,00 60 0,002				9,00 60 0,006	
	150   Cake Server Espátula para Pastel	mm Un. m <sup>3</sup>			867   Dessert Knife (Solid Handle) Cuchillo para Postre Forjado	mm Un. m <sup>3</sup>	
		2,50 12 0,009				4,00 60 0,005	
	170   Carving set Juego de cubiertos Trinchantes	mm Un. m <sup>3</sup>			980   Steak Knife (Solid Handle) Cuchillo para Asado Forjado	mm Un. m <sup>3</sup>	
		•2,50 12 0,007				9,50 60 0,007	
		••11,00			987   Steak Knife (Solid Handle) Cuchillo para Asado Forjado	mm Un. m <sup>3</sup>	
	190   Ladle Cazo Mediano	mm Un. m <sup>3</sup>				6,00 60 0,007	
		2,50 12 0,007					

































63932

# Italy

	010   Table Spoon Cuchara de Mesa mm Un. m <sup>3</sup> 2,50 60 0,006		210   Sauce Ladle Cazo de Salsa Pequeño mm Un. m <sup>3</sup> 2,50 12 0,003
	020   Table Fork Tenedor de Mesa mm Un. m <sup>3</sup> 2,50 60 0,005		250   Fish Fork Tenedor para Pescado mm Un. m <sup>3</sup> 2,50 60 0,003
	040   Dessert Spoon Cuchara para Postre mm Un. m <sup>3</sup> 2,25 60 0,006		260   Fish Knife Cuchillo para Pescado mm Un. m <sup>3</sup> 2,50 60 0,003
	050   Dessert Fork Tenedor para Postre mm Un. m <sup>3</sup> 2,25 60 0,003		270   Fish Server Juego para Servir Pescado mm Un. m <sup>3</sup> 2,50 12 0,009
	070   Tea Spoon Cuchara para Té mm Un. m <sup>3</sup> 2,00 60 0,002		280   Soup Spoon Cuchara para Sopa mm Un. m <sup>3</sup> 2,25 60 0,006
	080   Coffee Spoon Cuchara para Café mm Un. m <sup>3</sup> 2,00 60 0,002		290   Special tea Spoon Cuchara Mediana mm Un. m <sup>3</sup> 2,00 60 0,006
	090   Soup Ladle Cazo para Sopa mm Un. m <sup>3</sup> 2,50 12 0,009		810   Fruit Knife Cuchillo para Fruta mm Un. m <sup>3</sup> 5,80 60 0,003
	100   Serving Spoon Cuchara para Servir mm Un. m <sup>3</sup> 2,50 12 0,004		830   Table Knife (Solid Handle) Cuchillo de Mesa Forjado mm Un. m <sup>3</sup> 9,00 60 0,007
	110   Sugar Spoon Cuchara para Azúcar mm Un. m <sup>3</sup> 2,00 60 0,002		837   Table Knife (Solid Handle) Cuchillo de Mesa Forjado mm Un. m <sup>3</sup> 6,00 60 0,007
	120   Salad Server Juego para Servir Ensalada mm Un. m <sup>3</sup> 2,50 12 0,009		860   Dessert Knife (Solid Handle) Cuchillo para Postre Forjado mm Un. m <sup>3</sup> 8,90 60 0,007
	140   Cake Fork Tenedor para Pastel mm Un. m <sup>3</sup> 2,00 60 0,002		867   Dessert Knife (Solid Handle) Cuchillo para Postre Forjado mm Un. m <sup>3</sup> 4,00 60 0,005
	150   Cake Server Espátula para Pastel mm Un. m <sup>3</sup> 2,50 12 0,007		980   Steak Knife (Solid Handle) Cuchillo para Asado Forjado mm Un. m <sup>3</sup> 9,00 60 0,007
	190   Ladle Cazo Mediano mm Un. m <sup>3</sup> 2,50 12 0,007		987   Steak Knife (Solid Handle) Cuchillo para Asado Forjado mm Un. m <sup>3</sup> 6,00 60 0,007





63934

# Berlin



010 | Table Spoon  
Cuchara de Mesa  
mm Un. m<sup>3</sup>  
2,50 60 0,006



020 | Table Fork  
Tenedor de Mesa  
mm Un. m<sup>3</sup>  
2,50 60 0,005



040 | Dessert Spoon  
Cuchara para Postre  
mm Un. m<sup>3</sup>  
2,25 60 0,006



050 | Dessert Fork  
Tenedor para Postre  
mm Un. m<sup>3</sup>  
2,25 60 0,003



070 | Tea Spoon  
Cuchara para Té  
mm Un. m<sup>3</sup>  
2,00 60 0,003



080 | Coffee Spoon  
Cuchara para Café  
mm Un. m<sup>3</sup>  
2,00 60 0,002



090 | Soup Ladle  
Cazo para Sopa  
mm Un. m<sup>3</sup>  
2,50 12 0,009



100 | Serving Spoon  
Cuchara para Servir  
mm Un. m<sup>3</sup>  
2,50 12 0,004



110 | Sugar Spoon  
Cuchara para Azúcar  
mm Un. m<sup>3</sup>  
2,00 60 0,002

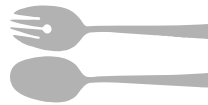

120 | Salad Server  
Juego para Servir Ensalada  
mm Un. m<sup>3</sup>  
2,50 12 0,012



140 | Cake Fork  
Tenedor para Pastel  
mm Un. m<sup>3</sup>  
2,00 60 0,002



150 | Cake Server  
Espátula para Pastel  
mm Un. m<sup>3</sup>  
2,50 12 0,009



210 | Sauce Ladle  
Cazo de Salsa Pequeño  
mm Un. m<sup>3</sup>  
2,50 12 0,003



250 | Fish Fork  
Tenedor para Pescado  
mm Un. m<sup>3</sup>  
2,50 60 0,003



260 | Fish Knife  
Cuchillo para Pescado  
mm Un. m<sup>3</sup>  
2,50 60 0,006



837 | Table Knife (Solid Handle)  
Cuchillo de Mesa Forjado  
mm Un. m<sup>3</sup>  
6,00 60 0,007



867 | Dessert Knife (Solid Handle)  
Cuchillo para Postre Forjado  
mm Un. m<sup>3</sup>  
4,00 60 0,005



















987 | Steak Knife (Solid Handle)  
Cuchillo para Asado Forjado  
mm Un. m<sup>3</sup>  
6,00 60 0,047



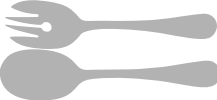

63986

# Zurique

	<b>010   Table Spoon</b> Cuchara de Mesa	mm	Un.	m <sup>3</sup>			
		2,50	60	0,005			
	<b>020   Table Fork</b> Tenedor de Mesa	mm	Un.	m <sup>3</sup>			
		2,50	60	0,005			
	<b>030   Table Knife</b> Cuchillo de Mesa	mm	Un.	m <sup>3</sup>			
		6,00	60	0,007			
	<b>040   Dessert Spoon</b> Cuchara para Postre	mm	Un.	m <sup>3</sup>			
		2,25	60	0,005			
	<b>050   Dessert Fork</b> Tenedor para Postre	mm	Un.	m <sup>3</sup>			
		2,25	60	0,003			
	<b>060   Dessert Knife</b> Cuchillo para Postre	mm	Un.	m <sup>3</sup>			
		4,00	60	0,005			
	<b>070   Tea Spoon</b> Cuchara para Té	mm	Un.	m <sup>3</sup>			
		2,00	60	0,002			
	<b>080   Coffee Spoon</b> Cuchara para Café	mm	Un.	m <sup>3</sup>			
		2,00	60	0,002			
	<b>090   Soup Ladle</b> Cazo para Sopa	mm	Un.	m <sup>3</sup>			
		2,50	12	0,007			
	<b>100   Serving Spoon</b> Cuchara para Servir	mm	Un.	m <sup>3</sup>			
		2,50	12	0,004			
	<b>110   Sugar Spoon</b> Cuchara para Azúcar	mm	Un.	m <sup>3</sup>			
		2,00	60	0,002			
	<b>120   Salad Server</b> Juego para Servir Ensalada	mm	Un.	m <sup>3</sup>			
		2,50	12	0,010			
	<b>140   Cake Fork</b> Tenedor para Pastel	mm	Un.	m <sup>3</sup>			
		2,00	60	0,002			
	<b>150   Cake Server</b> Espátula para Pastel	mm	Un.	m <sup>3</sup>			
		2,50	12	0,010			
	<b>180   Steak Knife</b> Cuchillo para Asado	mm	Un.	m <sup>3</sup>			
		6,00	60	0,007			
	<b>250   Fish Fork</b> Tenedor para Pescado	mm	Un.	m <sup>3</sup>			
		2,50	60	0,003			
	<b>260   Fish Knife</b> Cuchillo para Pescado	mm	Un.	m <sup>3</sup>			
		2,50	60	0,003			







63982

# Satri



010   Table Spoon Cuchara de Mesa		
mm	Un.	m <sup>3</sup>
2,50	60	0,006



020   Table Fork Tenedor de Mesa		
mm	Un.	m <sup>3</sup>
2,50	60	0,005



030   Table Knife Cuchillo de Mesa		
mm	Un.	m <sup>3</sup>
5,90	60	0,007



040   Dessert Spoon Cuchara para Postre		
mm	Un.	m <sup>3</sup>
2,25	60	0,006



050   Dessert Fork Tenedor para Postre		
mm	Un.	m <sup>3</sup>
2,25	60	0,003



060   Dessert Knife Cuchillo para Postre		
mm	Un.	m <sup>3</sup>
3,90	60	0,008



070   Tea Spoon Cuchara para Té		
mm	Un.	m <sup>3</sup>
2,00	60	0,003



080   Coffee Spoon Cuchara para Café		
mm	Un.	m <sup>3</sup>
1,60	60	0,002



090   Soup Ladle Cazo para Sopa		
mm	Un.	m <sup>3</sup>
2,50	12	0,009



100   Serving Spoon Cuchara para Servir		
mm	Un.	m <sup>3</sup>
2,50	12	0,004



110   Sugar Spoon Cuchara para Azúcar		
mm	Un.	m <sup>3</sup>
2,00	60	0,002



120   Salad Server Juego para Servir Ensalada		
mm	Un.	m <sup>3</sup>
2,50	12	0,012



mm	Un.	m <sup>3</sup>
2,50	12	0,012



140   Cake Fork Tenedor para Pastel		
mm	Un.	m <sup>3</sup>
2,00	60	0,002



150   Cake Server Espátula para Pastel		
mm	Un.	m <sup>3</sup>
2,50	12	0,007



180   Steak Knife Cuchillo para Asado		
mm	Un.	m <sup>3</sup>
5,90	60	0,047



250   Fish Fork Tenedor para Pescado		
mm	Un.	m <sup>3</sup>
2,25	60	0,003



260   Fish Knife Cuchillo para Pescado		
mm	Un.	m <sup>3</sup>
2,25	60	0,003



















810   Fruit Knife Cuchillo para Fruta		
mm	Un.	m <sup>3</sup>
6,00	60	0,003





63985























# Oslo

	<b>010   Table Spoon</b> Cuchara de Mesa	mm	Un.	m <sup>3</sup>	
		2,50	60	0,005	
	<b>020   Table Fork</b> Tenedor de Mesa	mm	Un.	m <sup>3</sup>	
		2,50	60	0,005	
	<b>030   Table Knife</b> Cuchillo de Mesa	mm	Un.	m <sup>3</sup>	
		5,70	60	0,007	
	<b>040   Dessert Spoon</b> Cuchara para Postre	mm	Un.	m <sup>3</sup>	
		2,25	60	0,005	
	<b>050   Dessert Fork</b> Tenedor para Postre	mm	Un.	m <sup>3</sup>	
		2,25	60	0,003	
	<b>060   Dessert Knife</b> Cuchillo para Postre	mm	Un.	m <sup>3</sup>	
		4,00	60	0,005	
	<b>070   Tea Spoon</b> Cuchara para Té	mm	Un.	m <sup>3</sup>	
		2,00	60	0,002	
	<b>080   Coffee Spoon</b> Cuchara para Café	mm	Un.	m <sup>3</sup>	
		2,00	60	0,002	
	<b>090   Soup Ladle</b> Cazo para Sopa	mm	Un.	m <sup>3</sup>	
		2,50	12	0,007	
	<b>100   Serving Spoon</b> Cuchara para Servir	mm	Un.	m <sup>3</sup>	
		2,50	12	0,004	
	<b>110   Sugar Spoon</b> Cuchara para Azúcar	mm	Un.	m <sup>3</sup>	
		2,00	60	0,002	
	<b>120   Salad Server</b> Juego para Servir Ensalada	mm	Un.	m <sup>3</sup>	
		2,50	12	0,010	
	<b>140   Cake Fork</b> Tenedor para Pastel	mm	Un.	m <sup>3</sup>	
		2,00	60	0,002	
	<b>150   Cake Server</b> Espátula para Pastel	mm	Un.	m <sup>3</sup>	
		2,50	12	0,010	
	<b>180   Steak Knife</b> Cuchillo para Asado	mm	Un.	m <sup>3</sup>	
		5,70	60	0,007	
	<b>280   Soup Spoon</b> Cuchara para Sopa	mm	Un.	m <sup>3</sup>	
		2,50	60	0,005	



63912

# Sonata





















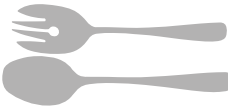

	010   Table Spoon Cuchara de Mesa	mm	Un.	m <sup>3</sup>			140   Cake Fork Tenedor para Pastel	mm	Un.	m <sup>3</sup>	
		2,25	60	0,006				1,60	60	0,002	
	020   Table Fork Tenedor de Mesa	mm	Un.	m <sup>3</sup>			150   Cake Server Espátula para Pastel	mm	Un.	m <sup>3</sup>	
		2,25	60	0,005				2,25	12	0,010	
	040   Dessert Spoon Cuchara para Postre	mm	Un.	m <sup>3</sup>			190   Ladle Cazo Mediano	mm	Un.	m <sup>3</sup>	
		2,00	60	0,006				2,50	12	0,007	
	050   Dessert Fork Tenedor para Postre	mm	Un.	m <sup>3</sup>			210   Sauce Ladle Cazo de Salsa Pequeño	mm	Un.	m <sup>3</sup>	
		2,00	60	0,003				2,25	12	0,003	
	070   Tea Spoon Cuchara para Té	mm	Un.	m <sup>3</sup>			240   Butter Spreader Espátula para Mantequilla	mm	Un.	m <sup>3</sup>	
		1,60	60	0,002				1,60	60	0,002	
	080   Coffee Spoon Cuchara para Café	mm	Un.	m <sup>3</sup>			250   Fish Fork Tenedor para Pescado	mm	Un.	m <sup>3</sup>	
		1,60	60	0,002				2,25	60	0,003	
	090   Soup Ladle Cazo para Sopa	mm	Un.	m <sup>3</sup>			260   Fish Knife Cuchillo para Pescado	mm	Un.	m <sup>3</sup>	
		2,50	12	0,009				2,25	60	0,003	
	100   Serving Spoon Cuchara para Servir	mm	Un.	m <sup>3</sup>			290   Special tea Spoon Cuchara Mediana	mm	Un.	m <sup>3</sup>	
		2,50	12	0,004				1,60	60	0,003	
	110   Sugar Spoon Cuchara para Azúcar	mm	Un.	m <sup>3</sup>			830   Table Knife (Solid Handle) Cuchillo de Mesa Forjado	mm	Un.	m <sup>3</sup>	
		1,60	60	0,002				6,00	60	0,007	
	120   Salad Server Juego para Servir Ensalada	mm	Un.	m <sup>3</sup>			860   Dessert Knife (Solid Handle) Cuchillo para Postre Forjado	mm	Un.	m <sup>3</sup>	
		2,25	12	0,012				3,70	60	0,005	
							980   Steak Knife (Solid Handle) Cuchillo para Asado Forjado	mm	Un.	m <sup>3</sup>	
								6,00	60	0,007	





63965

# Continental

	010   Table Spoon Cuchara de Mesa	mm	Un.	m <sup>3</sup>			
		2,25	60	0,006			
	020   Table Fork Tenedor de Mesa	mm	Un.	m <sup>3</sup>			
		2,25	60	0,003			
	030   Table Knife Cuchillo de Mesa	mm	Un.	m <sup>3</sup>			
		6,70	60	0,007			
	040   Dessert Spoon Cuchara para Postre	mm	Un.	m <sup>3</sup>			
		2,00	60	0,006			
	050   Dessert Fork Tenedor para Postre	mm	Un.	m <sup>3</sup>			
		2,00	60	0,003			
	060   Dessert Knife Cuchillo para Postre	mm	Un.	m <sup>3</sup>			
		6,00	60	0,006			
	070   Tea Spoon Cuchara para Té	mm	Un.	m <sup>3</sup>			
		1,60	60	0,002			
	080   Coffee Spoon Cuchara para Café	mm	Un.	m <sup>3</sup>			
		1,20	60	0,002			
	090   Soup Ladle Cazo para Sopa	mm	Un.	m <sup>3</sup>			
		2,50	12	0,009			
	100   Serving Spoon Cuchara para Servir	mm	Un.	m <sup>3</sup>			
		2,50	12	0,004			
	110   Sugar Spoon Cuchara para Azúcar	mm	Un.	m <sup>3</sup>			
		1,60	60	0,002			
	120   Salad Server Juego para Servir Ensalada	mm	Un.	m <sup>3</sup>			
		2,25	12	0,012			
	140   Cake Fork Tenedor para Pastel	mm	Un.	m <sup>3</sup>			
		1,60	60	0,002			
	150   Cake Server Espátula para Pastel	mm	Un.	m <sup>3</sup>			
		2,25	12	0,007			
	180   Steak Knife Cuchillo para Asado	mm	Un.	m <sup>3</sup>			
		4,00	60	0,007			
	190   Ladle Cazo Mediano	mm	Un.	m <sup>3</sup>			
		2,50	12	0,007			
	210   Sauce Ladle Cazo de Salsa Pequeño	mm	Un.	m <sup>3</sup>			
		2,25	12	0,003			
	250   Fish Fork Tenedor para Pescado	mm	Un.	m <sup>3</sup>			
		2,25	60	0,003			
	260   Fish Knife Cuchillo para Pescado	mm	Un.	m <sup>3</sup>			
		2,25	60	0,003			
	270   Fish Server Juego para Servir Pescado	mm	Un.	m <sup>3</sup>			
		2,25	12	0,009			
	290   Special tea Spoon Cuchara Mediana	mm	Un.	m <sup>3</sup>			
		1,60	60	0,003			
	830   Table Knife Cuchillo de Mesa	mm	Un.	m <sup>3</sup>			
		4,00	60	0,007			
	860   Dessert Knife Cuchillo para Postre	mm	Un.	m <sup>3</sup>			
		3,00	60	0,006			















63960

# Amazonas



010 | Table Spoon  
Cuchara de Mesa  
mm Un. m<sup>3</sup>  
2,25 300 0,018



020 | Table Fork  
Tenedor de Mesa  
mm Un. m<sup>3</sup>  
2,00 300 0,013



030 | Table Knife  
Cuchillo de Mesa  
mm Un. m<sup>3</sup>  
4,00 300 0,024



040 | Dessert Spoon  
Cuchara para Postre  
mm Un. m<sup>3</sup>  
1,80 300 0,017



050 | Dessert Fork  
Tenedor para Postre  
mm Un. m<sup>3</sup>  
1,60 300 0,013



060 | Dessert Knife  
Cuchillo para Postre  
mm Un. m<sup>3</sup>  
3,00 300 0,024



070 | Tea Spoon  
Cuchara para Té  
mm Un. m<sup>3</sup>  
1,20 300 0,010



080 | Coffee Spoon  
Cuchara para Café  
mm Un. m<sup>3</sup>  
1,00 300 0,007



090 | Soup Ladle  
Cazo para Sopa  
mm Un. m<sup>3</sup>  
2,00 36 0,023



100 | Serving Spoon  
Cuchara para Servir  
mm Un. m<sup>3</sup>  
2,25 48 0,012



110 | Sugar Spoon  
Cuchara para Azúcar  
mm Un. m<sup>3</sup>  
1,20 300 0,012



120 | Salad Server  
Juego para Servir Ensalada  
mm Un. m<sup>3</sup>  
2,25 48 0,015



140 | Cake Fork  
Tenedor para Pastel  
mm Un. m<sup>3</sup>  
1,20 300 0,007



150 | Cake Server  
Espátula para Pastel  
mm Un. m<sup>3</sup>  
2,00 36 0,021



188 | Steak Knife  
Cuchillo para Asado  
mm Un. m<sup>3</sup>  
4,00 300 0,031



200 | Ice Drink Spoon  
Cuchara para Refresco  
mm Un. m<sup>3</sup>  
1,20 300 0,002



210 | Sauce Ladle  
Cazo de Salsa Pequeño  
mm Un. m<sup>3</sup>  
2,00 36 0,013



240 | Butter Spreader  
Espátula para Mantequilla  
mm Un. m<sup>3</sup>  
1,20 300 0,005



250 | Fish Fork  
Tenedor para Pescado  
mm Un. m<sup>3</sup>  
2,00 180 0,013



260 | Fish Knife  
Cuchillo para Pescado  
mm Un. m<sup>3</sup>  
2,00 180 0,013



280 | Soup Spoon  
Cuchara para Sopa  
mm Un. m<sup>3</sup>  
2,00 300 0,027



740 | Appetizer Fork  
Tenedor de Aperitivo  
mm Un. m<sup>3</sup>  
1,20 300 0,007



810 | Fruit Knife  
Cuchillo para Fruta  
mm Un. m<sup>3</sup>  
4,00 60 0,003



840 | Pizza Fork  
Tenedor para Pizza  
mm Un. m<sup>3</sup>  
2,00 120 0,003



890 | Pizza Knife  
Cuchillo para Pizza  
mm Un. m<sup>3</sup>  
4,00 120 0,004



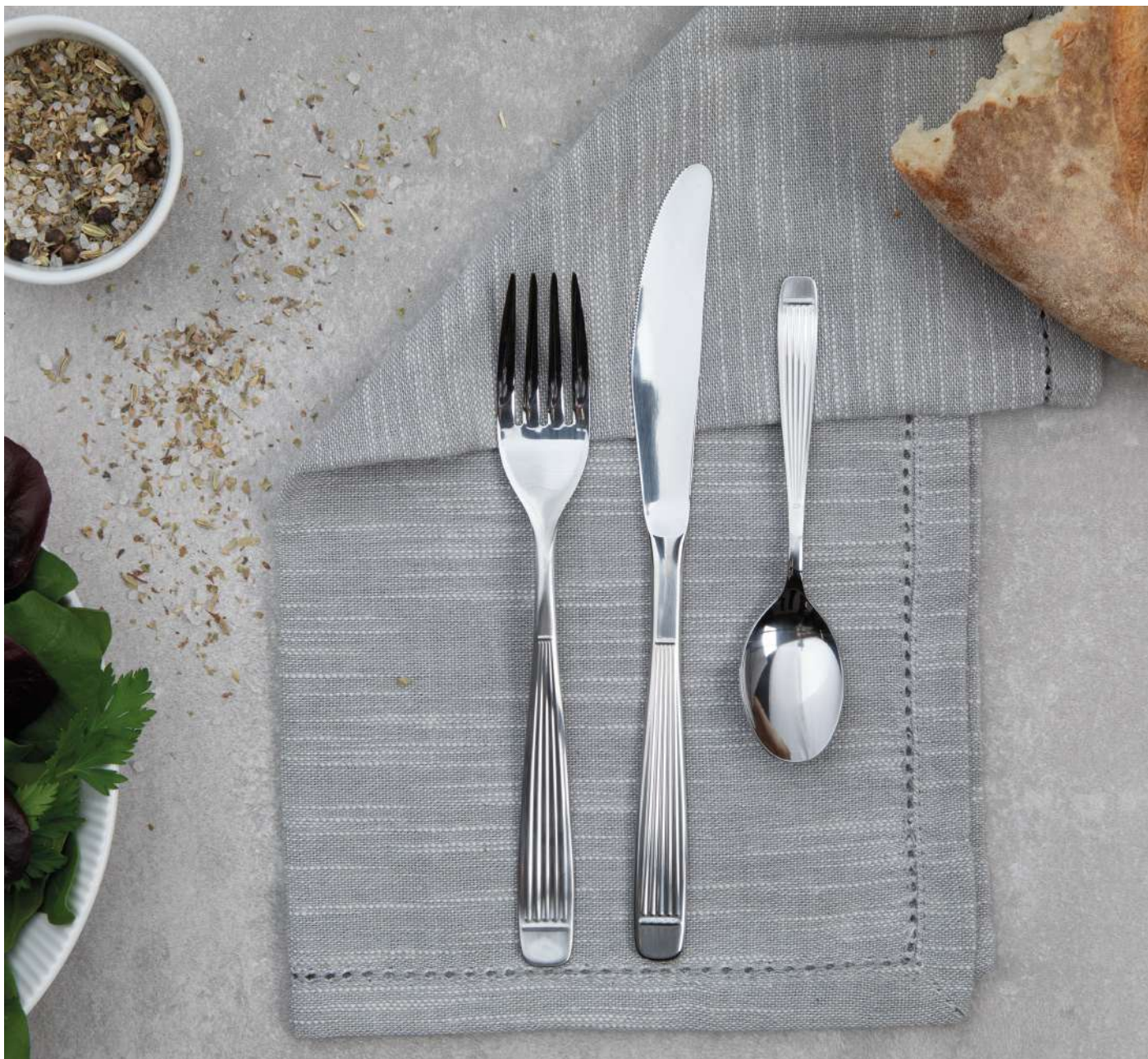

63940

# Athenas



017 | Table Spoon  
Cuchara de Mesa  
mm Un. m<sup>3</sup>  
2,25 300 0,012



027 | Table Fork  
Tenedor de Mesa  
mm Un. m<sup>3</sup>  
2,00 300 0,013



037 | Table Knife  
Cuchillo de Mesa  
mm Un. m<sup>3</sup>  
4,00 300 0,013



047 | Dessert Spoon  
Cuchara para Postre  
mm Un. m<sup>3</sup>  
1,80 300 0,013



057 | Dessert Fork  
Tenedor para Postre  
mm Un. m<sup>3</sup>  
1,60 300 0,007



067 | Dessert Knife  
Cuchillo para Postre  
mm Un. m<sup>3</sup>  
3,00 300 0,013



077 | Tea Spoon  
Cuchara para Té  
mm Un. m<sup>3</sup>  
1,20 300 0,006



087 | Coffee Spoon  
Cuchara para Café  
mm Un. m<sup>3</sup>  
1,00 300 0,004



090 | Soup Ladle  
Cazo para Sopa  
mm Un. m<sup>3</sup>  
2,00 36 0,023



100 | Serving Spoon  
Cuchara para Servir  
mm Un. m<sup>3</sup>  
2,25 48 0,007



110 | Sugar Spoon  
Cuchara para Azúcar  
mm Un. m<sup>3</sup>  
1,20 300 0,007



120 | Salad Server  
Juego para Servir Ensalada  
mm Un. m<sup>3</sup>



2,00 48 0,015



140 | Cake Fork  
Tenedor para Pastel  
mm Un. m<sup>3</sup>  
1,20 300 0,006



150 | Cake Server  
Espátula para Pastel  
mm Un. m<sup>3</sup>  
2,00 36 0,013



187 | Steak Knife  
Cuchillo para Asado  
mm Un. m<sup>3</sup>  
4,00 300 0,020



190 | Ladle  
Cazo Mediano  
mm Un. m<sup>3</sup>  
2,00 24 0,013



210 | Sauce Ladle  
Cazo de Salsa Pequeño  
mm Un. m<sup>3</sup>  
2,00 36 0,007



240 | Butter Spreader  
Espátula para Mantequilla  
mm Un. m<sup>3</sup>  
1,20 300 0,006



250 | Fish Fork  
Tenedor para Pescado  
mm Un. m<sup>3</sup>  
2,00 180 0,007



260 | Fish Knife  
Cuchillo para Pescado  
mm Un. m<sup>3</sup>  
2,00 180 0,007



270 | Fish Server  
Juego para Servir Pescado  
mm Un. m<sup>3</sup>



2,00 60 0,028



290 | Special Tea Spoon  
Cuchara Mediana  
mm Un. m<sup>3</sup>  
1,60 300 0,013

































63950

# Cosmos

	017   Table Spoon Cuchara de Mesa mm Un. m <sup>3</sup> 2,25 300 0,012		150   Cake Server Espátula para Pastel mm Un. m <sup>3</sup> 2,00 36 0,013
	027   Table Fork Tenedor de Mesa mm Un. m <sup>3</sup> 2,00 300 0,013		187   Steak Knife Cuchillo para Asado mm Un. m <sup>3</sup> 4,00 300 0,020
	037   Table Knife Cuchillo de Mesa mm Un. m <sup>3</sup> 4,00 300 0,013		190   Ladle Cazo Mediano mm Un. m <sup>3</sup> 2,00 24 0,013
	047   Dessert Spoon Cuchara para Postre mm Un. m <sup>3</sup> 1,80 300 0,013		200   Ice Drink Spoon Cuchara para Refresco mm Un. m <sup>3</sup> 2,00 300 0,013
	057   Dessert Fork Tenedor para Postre mm Un. m <sup>3</sup> 1,60 300 0,007		210   Sauce Ladle Cazo de Salsa Pequeño mm Un. m <sup>3</sup> 2,00 36 0,007
	067   Dessert Knife Cuchillo para Postre mm Un. m <sup>3</sup> 3,00 300 0,013		240   Butter Spreader Espátula para Mantequilla mm Un. m <sup>3</sup> 1,20 300 0,006
	077   Tea Spoon Cuchara para Té mm Un. m <sup>3</sup> 1,20 300 0,006		250   Fish Fork Tenedor para Pescado mm Un. m <sup>3</sup> 2,00 180 0,007
	087   Coffee Spoon Cuchara para Café mm Un. m <sup>3</sup> 1,00 300 0,004		260   Fish Knife Cuchillo para Pescado mm Un. m <sup>3</sup> 2,00 180 0,007
	090   Soup Ladle Cazo para Sopa mm Un. m <sup>3</sup> 2,00 36 0,023		270   Fish Server Juego para Servir Pescado mm Un. m <sup>3</sup> 2,00 60 0,028
	100   Serving Spoon Cuchara para Servir mm Un. m <sup>3</sup> 2,25 48 0,007		290   Special Tea Spoon Cuchara Mediana mm Un. m <sup>3</sup> 1,60 300 0,013
	110   Sugar Spoon Cuchara para Azúcar mm Un. m <sup>3</sup> 1,20 300 0,007		470   Carving Fork Tenedor Trinchante mm Un. m <sup>3</sup> 2,25 36 0,004
	120   Salad Server Juego para Servir Ensalada mm Un. m <sup>3</sup> 2,00 48 0,015		840   Pizza Fork Tenedor para pizza mm Un. m <sup>3</sup> 2,00 120 0,003
	140   Cake Fork Tenedor para Pastel mm Un. m <sup>3</sup> 1,20 300 0,006		890   Pizza Knife Cuchillo para pizza mm Un. m <sup>3</sup> 4,00 120 0,005



















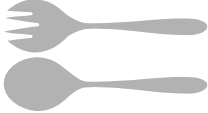



63903

# Angra

























	010   Table Spoon Cuchara de Mesa	mm	Un.	m <sup>3</sup>			
		1,80	300	0,012			
	020   Table Fork Tenedor de Mesa	mm	Un.	m <sup>3</sup>			
		1,60	300	0,013			
	030   Table Knife Cuchillo de Mesa	mm	Un.	m <sup>3</sup>			
		3,00	300	0,013			
	040   Dessert Spoon Cuchara para Postre	mm	Un.	m <sup>3</sup>			
		1,20	300	0,013			
	050   Dessert Fork Tenedor para Postre	mm	Un.	m <sup>3</sup>			
		1,20	300	0,007			
	060   Dessert Knife Cuchillo para Postre	mm	Un.	m <sup>3</sup>			
		2,70	300	0,013			
	070   Tea Spoon Cuchara para Té	mm	Un.	m <sup>3</sup>			
		1,20	300	0,006			
	080   Coffee Spoon Cuchara para Café	mm	Un.	m <sup>3</sup>			
		0,80	300	0,006			
	100   Serving Spoon Cuchara para Servir	mm	Un.	m <sup>3</sup>			
		2,25	48	0,007			
	120   Salad Server Juego para Servir Ensalada	mm	Un.	m <sup>3</sup>			
		1,80	48	0,015			
	140   Cake Fork Tenedor para Pastel	mm	Un.	m <sup>3</sup>			
		1,20	300	0,006			
	150   Cake Server Espátula para Pastel	mm	Un.	m <sup>3</sup>			
		1,60	36	0,023			
	180   Steak Knife Cuchillo para Asado	mm	Un.	m <sup>3</sup>			
		3,00	300	0,013			
	190   Ladle Cazo Mediano	mm	Un.	m <sup>3</sup>			
		2,50	24	0,013			
	200   Ice drink Spoon Cuchara para Refresco	mm	Un.	m <sup>3</sup>			
		1,20	300	0,013			
	240   Butter Spreader Espátula para Mantequilla	mm	Un.	m <sup>3</sup>			
		1,00	300	0,006			
	300   Special Tea Spoon Cuchara Mediana	mm	Un.	m <sup>3</sup>			
		1,20	300	0,013			
	470   Carving Fork Tenedor Trinchante	mm	Un.	m <sup>3</sup>			
		2,25	36	0,004			



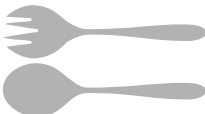

63906

# Laguna

	010   Table Spoon Cuchara de Mesa mm Un. m <sup>3</sup> 1,80 300 0,012		140   Cake Fork Tenedor para Pastel mm Un. m <sup>3</sup> 1,20 300 0,006
	020   Table Fork Tenedor de Mesa mm Un. m <sup>3</sup> 1,60 300 0,013		150   Cake Server Espátula para Pastel mm Un. m <sup>3</sup> 1,60 36 0,023
	030   Table Knife Cuchillo de Mesa mm Un. m <sup>3</sup> 3,00 300 0,013		180   Steak Knife Cuchillo para Asado mm Un. m <sup>3</sup> 3,00 300 0,013
	040   Dessert Spoon Cuchara para Postre mm Un. m <sup>3</sup> 1,20 300 0,013		190   Ladle Cazo Mediano mm Un. m <sup>3</sup> 2,50 24 0,013
	050   Dessert Fork Tenedor para Postre mm Un. m <sup>3</sup> 1,20 300 0,007		200   Ice drink Spoon Cuchara para Refresco mm Un. m <sup>3</sup> 1,20 300 0,013
	060   Dessert Knife Cuchillo para Postre mm Un. m <sup>3</sup> 2,70 300 0,013		210   Sauce Ladle Cazo de Salsa Pequeño mm Un. m <sup>3</sup> 1,60 36 0,006
	070   Tea Spoon Cuchara para Té mm Un. m <sup>3</sup> 1,20 300 0,006		220   Skimmer Espumadera mm Un. m <sup>3</sup> 2,00 36 0,017
	080   Coffee Spoon Cuchara para Café mm Un. m <sup>3</sup> 0,80 300 0,006		240   Butter Spreader Espátula para Mantequilla mm Un. m <sup>3</sup> 1,00 300 0,006
	090   Soup Ladle Cazo para Sopa mm Un. m <sup>3</sup> 2,00 36 0,023		300   Special Tea Spoon Cuchara Mediana mm Un. m <sup>3</sup> 1,20 300 0,013
	100   Serving Spoon Cuchara para Servir mm Un. m <sup>3</sup> 2,25 48 0,007		470   Carving Fork Tenedor Trinchant mm Un. m <sup>3</sup> 2,25 36 0,004
	110   Sugar Spoon Cuchara para Azúcar mm Un. m <sup>3</sup> 1,00 300 0,007		840   Pizza Fork Tenedor para Pizza mm Un. m <sup>3</sup> 1,60 120 0,003
	120   Salad Server Juego para Servir Ensalada mm Un. m <sup>3</sup> 1,80 48 0,015		890   Pizza Knife Cuchillo para Pizza mm Un. m <sup>3</sup> 3,00 120 0,005





























63902















# Maresias

	010   Table Spoon Cuchara de Mesa	mm Un. m <sup>3</sup>			120   Salad Server Juego para Servir Ensalada	mm Un. m <sup>3</sup>	
		1,80 300 0,012				1,80 48 0,015	
	027   Table Fork Tenedor de Mesa	mm Un. m <sup>3</sup>			140   Cake Fork Tenedor para Pastel	mm Un. m <sup>3</sup>	
		1,60 300 0,013				1,20 300 0,006	
	030   Table Knife Cuchillo de Mesa	mm Un. m <sup>3</sup>			150   Cake Server Espátula para Pastel	mm Un. m <sup>3</sup>	
		3,00 300 0,013				1,60 36 0,013	
	040   Dessert Spoon Cuchara para Postre	mm Un. m <sup>3</sup>			180   Steak Knife Cuchillo para Asado	mm Un. m <sup>3</sup>	
		1,20 300 0,013				3,00 300 0,013	
	050   Dessert Fork Tenedor para Postre	mm Un. m <sup>3</sup>			190   Ladle Cazo mediano	mm Un. m <sup>3</sup>	
		1,20 300 0,007				2,00 24 0,013	
	060   Dessert Knife Cuchillo para Postre	mm Un. m <sup>3</sup>			200   Ice drink Spoon Cuchara para refresco	mm Un. m <sup>3</sup>	
		2,50 300 0,013				1,20 300 0,013	
	070   Tea Spoon Cuchara para Té	mm Un. m <sup>3</sup>			210   Sauce Ladle Cazo de Salsa Pequeño	mm Un. m <sup>3</sup>	
		1,00 300 0,006				1,60 36 0,007	
	080   Coffee Spoon Cuchara para Café	mm Un. m <sup>3</sup>			220   Skimmer Espumadera	mm Un. m <sup>3</sup>	
		0,80 300 0,004				2,00 36 0,017	
	090   Soup Ladle Cazo para Sopa	mm Un. m <sup>3</sup>			300   Special tea Spoon Cuchara Mediana	mm Un. m <sup>3</sup>	
		2,00 36 0,023				1,20 300 0,013	
	100   Serving Spoon Cuchara para Servir	mm Un. m <sup>3</sup>			740   Appetizer Fork Tenedor de Aperitivo	mm Un. m <sup>3</sup>	
		2,25 48 0,007				1,20 300 0,069	
	110   Sugar Spoon Cuchara para Azúcar	mm Un. m <sup>3</sup>			750   Appetizer Spoon Cuchara para Aperitivo	mm Un. m <sup>3</sup>	
		1,00 300 0,007				1,20 300 0,069	



63945

# Havana

	010   Table Spoon Cuchara de Mesa	mm	Un.	m <sup>3</sup>		120   Salad Server Juego para Servir Ensalada	mm	Un.	m <sup>3</sup>
		1,50	300	0,012			1,50	48	0,012
	020   Table Fork Tenedor de Mesa	mm	Un.	m <sup>3</sup>		140   Cake Fork Tenedor para Pastel	mm	Un.	m <sup>3</sup>
		1,50	300	0,013			1,20	300	0,005
	030   Table Knife Cuchillo de Mesa	mm	Un.	m <sup>3</sup>		150   Cake Server Espátula para Pastel	mm	Un.	m <sup>3</sup>
		2,60	300	0,013			1,50	36	0,011
	040   Dessert Spoon Cuchara para Postre	mm	Un.	m <sup>3</sup>		180   Steak Knife Cuchillo para Asado	mm	Un.	m <sup>3</sup>
		1,20	300	0,011			2,60	300	0,006
	070   Tea Spoon Cuchara para Té	mm	Un.	m <sup>3</sup>		190   Ladle Cazo Mediano	mm	Un.	m <sup>3</sup>
		1,00	300	0,013			2,00	24	0,011
	080   Coffee Spoon Cuchara para Café	mm	Un.	m <sup>3</sup>		470   Carving Fork Tenedor Trinchant	mm	Un.	m <sup>3</sup>
		0,80	300	0,005			2,00	36	0,004
	100   Serving Spoon Cuchara para Servir	mm	Un.	m <sup>3</sup>					
		2,00	48	0,007					





63905

# Havaí



010 | Table Spoon  
Cuchara de Mesa  
mm Un. m<sup>3</sup>  
1,60 300 0,012



020 | Table Fork  
Tenedor de Mesa  
mm Un. m<sup>3</sup>  
1,60 300 0,012



030 | Table Knife  
Cuchillo de Mesa  
mm Un. m<sup>3</sup>  
2,70 300 0,012



070 | Tea Spoon  
Cuchara para Té  
mm Un. m<sup>3</sup>  
1,00 300 0,007



080 | Coffee Spoon  
Cuchara para Café  
mm Un. m<sup>3</sup>  
0,80 300 0,005



140 | Cake Fork  
Tenedor para Pastel  
mm Un. m<sup>3</sup>  
1,20 300 0,006



180 | Steak Knife  
Cuchillo para Asado  
mm Un. m<sup>3</sup>  
2,70 300 0,012



300 | Special tea Spoon  
Cuchara Mediana  
mm Un. m<sup>3</sup>  
1,20 300 0,012









# Baguette

63989



830   Table Knife Cuchara de Mesa		
mm	Un.	m <sup>3</sup>
9,00	60	0,007

**See on the side how the Baguette knife** is a wildcard product: the design it matches the Cannes lines, Classic, Firenze and Zurique.

**Mira en el lateral cómo el cuchillo Baguette** es un producto comodín: el diseño coincide con las líneas de Cannes, Classic, Firenze y Zurique.





AN UNFORGETTABLE GIFT | UN REGALO INOLVIDABLE

# FLATWARE SETS

## JUEGOS DE CUBIERTOS

---

One of the essential items for people who are settling into a new home is stylish, long-lasting tableware. Tramontina's refined tableware sets have options for all styles and preferences and feature distinguished items that do beautifully well for all family sizes. Whether it is a wedding registry or a gift list for a housewarming party, tableware sets are a definite part of these rites of passage and cannot be left out.

Uno de los artículos esenciales para quienes están armando su nueva casa son cubiertos elegantes y duraderos. La línea de juegos de cubiertos finos de Tramontina tiene opciones para todos los estilos y preferencias y cuenta con diferenciales que se lucen en todos los tamaños de familia. Ya sea en una lista de novias o en una lista de regalos de inauguración de casa nueva, lo cierto es que los juegos de cubiertos forman parte de esos momentos y no pueden quedar afuera.



## CONTENTS OF FLATWARE SETS CONTENIDO DE LOS JUEGOS DE CUBIERTOS

# 24

### Pc./Pzas.

6 Table Spoons / Cucharas de Mesa  
6 Table Forks / Tenedores de Mesa  
6 Table Knives / Cuchillos de Mesa  
6 Tea Spoons / Cucharas para Té

# 101

### Pc./Pzas.

12 Table Spoons / Cucharas de Mesa  
12 Table Forks / Tenedores de Mesa  
12 Table Knives / Cuchillos de Mesa  
12 Dessert Spoons / Cucharas para Postre  
12 Dessert Forks / Tenedores para Postre  
12 Dessert Knives / Cuchillos para Postre  
12 Tea Spoons / Cucharas para Té  
12 Coffee Spoons / Cucharas para Café  
1 Soup Ladle / Cazo para Sopa  
1 Serving Spoon / Cuchara para Servir  
1 Sugar Spoon / Cuchara para Azúcar  
1 Salad Spoon / Cuchara para Ensalada  
1 Salad Fork / Tenedor para Ensalada

# 42

### Pc./Pzas.

6 Table Spoons / Cucharas de Mesa  
6 Table Forks / Tenedores de Mesa  
6 Table Knives / Cuchillos de Mesa  
6 Dessert Spoons / Cucharas para Postre  
6 Dessert Forks / Tenedores para Postre  
6 Dessert Knives / Cuchillos para Postre  
6 Tea Spoons / Cucharas para Té

# 130

### Pc./Pzas.

12 Table Spoons / Cucharas de Mesa  
12 Table Forks / Tenedores de Mesa  
12 Table Knives / Cuchillos de Mesa  
12 Dessert Spoons / Cucharas para Postre  
12 Dessert Forks / Tenedores para Postre  
12 Dessert Knives / Cuchillos para Postre  
12 Tea Spoons / Cucharas para Té  
12 Coffee Spoons / Cucharas para Café  
1 Soup Ladle / Cazo para Sopa  
1 Serving Spoon / Cuchara para Servir  
1 Sugar Spoon / Cuchara para Azúcar  
1 Salad Spoon / Cuchara para Ensalada  
1 Salad Fork / Tenedor para Ensalada  
1 Carving Knife / Cuchillo Trinchante para Carne

# 76

### Pc./Pzas.

12 Table Spoons / Cucharas de Mesa  
12 Table Forks / Tenedores de Mesa  
12 Table Knives / Cuchillos de Mesa  
12 Dessert Spoons / Cucharas para Postre  
12 Coffee Spoons / Cucharas para Café  
1 Serving Spoon / Cuchara para Servir  
1 Salad Spoon / Cuchara para Ensalada  
1 Salad Fork / Tenedor para Ensalada  
12 Cake Forks / Tenedores para Pastel  
1 Cake Server / Espátula para Pastel

1 Carving Fork / Tenedor Trinchante para Carne  
1 Sauce Ladle / Cazo de Salsa Pequeño  
12 Fish Forks / Tenedores para Pescado  
12 Fish Knives / Cuchillos para Pescado  
1 Fish Knife / Cuchillo Trinchante para Pescado  
1 Fish Fork / Tenedor Trinchante para Pescado









**FLATWARE SET  
JUEGO DE CUBIERTOS  
76 PC./PZAS.**

	Ref.	Un.	m <sup>3</sup>	7891116
Renascença	66929/352	01	0,032	051429

**101 Pc./Pzas.**

	Ref.	Un.	m <sup>3</sup>	7891116
Renascença	66929/232	01	0,040	051436

**130 Pc./Pzas.**

	Ref.	Un.	m <sup>3</sup>	7891116
Renascença	66929/242	01	0,048	051443





**FLATWARE SET  
JUEGO DE CUBIERTOS  
42 PC./PZAS.  
Solid handle knives  
Cuchillos forjados**

	Ref.	Un.	m <sup>3</sup>	7891116
Cannes	66979/203	01	0,014	116678
Classic	66928/203	01	0,013	078624
Vicenza	66924/203	01	0,014	105177
Firenze	66925/203	01	0,014	083703

Contents / Contenido:  
 6 Table Spoons / Cucharas de Mesa  
 6 Table Forks / Tenedores de Mesa  
 6 Table Knives / Cuchillos de Mesa  
 6 Dessert Spoons / Cucharas para Postre  
 6 Dessert Forks / Tenedores para Postre  
 6 Dessert Knives / Cuchillos para Postre  
 6 Coffee Spoons / Cucharas para Café



**FLATWARE SET  
JUEGO DE CUBIERTOS  
76 PC./PZAS.  
Hollow-handle knives  
Cuchillos de mango hueco**

	Ref.	Un.	m <sup>3</sup>	7891116
Renascença	66929/300	01	0,024	150412

**Solid handle knives  
Cuchillos forjados**

	Ref.	Un.	m <sup>3</sup>	7891116
Cannes	66979/300	01	0,024	124239
Classic	66928/300	01	0,024	052686
Vicenza	66924/305	01	0,024	105184
Firenze	66925/305	01	0,023	083376

Contents / Contenido:  
 12 Table Spoons / Cucharas de Mesa  
 12 Table Forks / Tenedores de Mesa  
 12 Table Knives / Cuchillos de Mesa  
 12 Dessert Spoons / Cucharas para Postre  
 12 Coffee Spoons / Cucharas para Café  
 1 Sugar Spoon / Cuchara para Azúcar  
 1 Salad Spoon / Cuchara para Ensalada  
 1 Salad Fork / Tenedor para Ensalada  
 12 Cake Forks / Tenedores para Pastel  
 1 Cake Server / Espátula para Pastel





FLATWARE SET  
 JUEGO DE CUBIERTOS  
 101 PC./PZAS.  
 Hollow-handle knives  
 Cuchillos de mango hueco

	Ref.	Un.	m <sup>3</sup>	7891116
Renascença	66929/213	01	0,032	150436

Solid handle knives  
 Cuchillos forjados

	Ref.	Un.	m <sup>3</sup>	7891116
Cannes	66979/215	01	0,033	116685
Classic	66928/215	01	0,028	050293
Vicenza	66924/215	01	0,033	105191
Firenze	66925/215	01	0,033	083383

Contents / Contenido:  
 12 Table Spoons / Cucharas de Mesa  
 12 Table Forks / Tenedores de Mesa  
 12 Table Knives / Cuchillos de Mesa  
 12 Dessert Spoons / Cucharas para Postre  
 12 Dessert Forks / Tenedores para Postre  
 12 Dessert Knives / Cuchillos para Postre  
 12 Tea Spoons / Cucharas para Té  
 12 Coffee Spoons / Cucharas para Café  
 1 Soup Ladle / Cazo para Sopa  
 1 Serving Spoon / Cuchara para Servir  
 1 Sugar Spoon / Cuchara para Azúcar  
 1 Salad Spoon / Cuchara para Ensalada  
 1 Salad Fork / Tenedor para Ensalada



FLATWARE SET  
 JUEGO DE CUBIERTOS  
 130 PC./PZAS.  
 Hollow-handle knives  
 Cuchillos de mango hueco

	Ref.	Un.	m <sup>3</sup>	7891116
Renascença	66929/225	01	0,043	150603

Solid handle knives  
 Cuchillos forjados

	Ref.	Un.	m <sup>3</sup>	7891116
Classic	66928/223	01	0,042	061305
Vicenza	66924/223	01	0,042	105214
Firenze	66925/223	01	0,042	083406

Contents | Contenido:  
 12 Table Spoons / Cucharas de Mesa  
 12 Table Forks / Tenedores de Mesa  
 12 Table Knives / Cuchillos de Mesa  
 12 Dessert Spoons / Cucharas para Postre  
 12 Dessert Forks / Tenedores para Postre  
 12 Dessert Knives / Cuchillos para Postre  
 12 Tea Spoons / Cucharas para Té  
 12 Coffee Spoons / Cucharas para Café  
 1 Soup Ladle / Cazo para Sopa  
 1 Serving Spoon / Cuchara para Servir  
 1 Sugar Spoon / Cuchara para Azúcar  
 1 Salad Spoon / Cuchara para Ensalada  
 1 Salad Fork / Tenedor para Ensalada  
 1 Carving Knife / Cuchillo Trinchante para Carne  
 1 Carving Fork / Tenedor Trinchante para Carne  
 1 Sauce Ladle / Cazo de Salsa Pequeño  
 12 Fish Forks / Tenedores para Pescado  
 12 Fish Knives / Cuchillos para Pescado  
 1 Fish Knife / Cuchillo Trinchante para Pescado  
 1 Fish Fork / Tenedor Trinchante para Pescado



FLATWARE SET  
JUEGO DE CUBIERTOS  
101 PC./PZAS.

	Ref.	Un.	m <sup>3</sup>	7891116
Mônaco	66917/030	01	0,014	166512

Contents / Contenido:  
 12 Table Spoons / Cucharas de Mesa  
 12 Table Forks / Tenedores de Mesa  
 12 Table Knives / Cuchillos de Mesa  
 12 Dessert Spoons / Cucharas para Postre  
 12 Dessert Forks / Tenedores para Postre  
 12 Dessert Knives / Cuchillos para Postre  
 12 Tea Spoons / Cucharas para Té  
 12 Coffee Spoons / Cucharas para Café  
 1 Soup Ladle / Cazo para Sopa  
 1 Serving Spoon / Cuchara para Servir  
 1 Sugar Spoon / Cuchara para Azúcar  
 1 Salad Spoon / Cuchara para Ensalada  
 1 Salad Fork / Tenedor para Ensalada

FLATWARE SET  
JUEGO DE CUBIERTOS  
24 PC./PZAS.  
Solid handle knives  
Cuchillos forjados

	Ref.	Un.	m <sup>3</sup>	7891116
Sonata	66912/000	06	0,061	029077
Italy	66932/005	06	0,061	073827
Berlin	66934/005	06	0,061	083772
Satri	66982/000	06	0,058	073568
Oslo	66985/000	06	0,061	083819
Zurique	66986/000	06	0,061	100486
Pacific	66962/005	06	0,061	081211
Classic	66928/003	06	0,061	150184
Vicenza	66924/003	06	0,061	150160
Firenze	66925/003	06	0,061	150177
Cannes	66979/003	06	0,061	150191

Hollow-handle knives  
Cuchillos de mango hueco

	Ref.	Un.	m <sup>3</sup>	7891116
Renascença	66929/000	06	0,061	048931

Solid handle knives 6mm  
Cuchillos forjados 6mm

	Ref.	Un.	m <sup>3</sup>	7891116
Sevilha	66915/000	06	0,061	013915
Italy	66932/007	06	0,061	147849
Mônaco	66917/007	06	0,061	147818

Contents / Contenido:  
 6 Table Spoons / Cucharas de Mesa  
 6 Table Forks / Tenedores de Mesa  
 6 Table Knives / Cuchillos de Mesa  
 6 Tea Spoons / Cucharas para Té





FLATWARE SET  
 JUEGO DE CUBIERTOS  
 42 PC./PZAS.  
 Solid handle knives  
 Cuchillos forjados

	Ref.	Un.	m <sup>3</sup>	7891116
Berlin	66934/204	01	0,013	150269
Satri	66982/203	01	0,013	150351
Zurique	66986/204	01	0,013	150290
Oslo	66985/204	01	0,013	150283
Sonata	66912/204	01	0,013	150306
Continental	66965/204	01	0,013	150276

Solid handle knives 6mm  
 Cuchillos forjados 6mm

	Ref.	Un.	m <sup>3</sup>	7891116
Italy	66932/207	01	0,013	150320
Mônaco	66917/207	01	0,013	150313

Contents / Contenido:

6 Table Spoons / Cucharas de Mesa  
 6 Table Forks / Tenedores de Mesa  
 6 Table Knives / Cuchillos de Mesa  
 6 Dessert Spoons / Cucharas para Postre  
 6 Dessert Forks / Tenedores para Postre  
 6 Dessert Knives / Cuchillos para Postre  
 6 Coffee Spoons / Cucharas para Café



FLATWARE SET  
 JUEGO DE CUBIERTOS  
 76 PC./PZAS.  
 Solid handle knives  
 Cuchillos forjados

	Ref.	Un.	m <sup>3</sup>	7891116
Berlin	66934/304	01	0,023	126721
Satri	66982/304	01	0,023	126738
Zurique	66986/304	01	0,023	126752
Oslo	66985/304	01	0,023	126745
Sonata	66912/304	01	0,023	150399
Continental	66965/304	01	0,023	129807
Pacific	66962/306	01	0,023	150405

Solid handle knives 6mm  
 Cuchillos forjados 6mm

	Ref.	Un.	m <sup>3</sup>	7891116
Sevilha	66915/304	01	0,023	150368
Italy	66932/307	01	0,023	032626
Mônaco	66917/307	01	0,023	064429

Contents / Contenido:

12 Table Spoons / Cucharas de Mesa  
 12 Table Forks / Tenedores de Mesa  
 12 Table Knives / Cuchillos de Mesa  
 12 Dessert Spoons / Cucharas para Postre  
 12 Coffee Spoons / Cucharas para Café  
 1 Sugar Spoon / Cuchara para Azúcar  
 1 Salad Spoon / Cuchara para Ensalada  
 1 Salad Fork / Tenedor para Ensalada  
 12 Cake Forks / Tenedores para Pastel  
 1 Cake Server / Espátula para Pastel





**FLATWARE SET  
JUEGO DE CUBIERTOS  
101 PC./PZAS.  
Solid handle knives  
Cuchillos forjados**

	Ref.	Un.	m <sup>3</sup>	7891116
Berlin	66934/214	01	0,034	126769
Satri	66982/214	01	0,034	126776
Zurique	66986/214	01	0,034	126790
Oslo	66985/214	01	0,034	126783
Sonata	66912/214	01	0,026	049600
Continental	66965/214	01	0,034	034354
Pacific	66962/214	01	0,026	150511

**Solid handle knives 6mm  
Cuchillos forjados 6mm**

	Ref.	Un.	m <sup>3</sup>	7891116
Italy	66932/217	01	0,027	147863
Mônaco	66917/217	01	0,027	147832

**Contents / Contenido:**

12 Table Spoons / Cucharas de Mesa  
12 Table Forks / Tenedores de Mesa  
12 Table Knives / Cuchillos de Mesa  
12 Dessert Spoons / Cucharas para Postre  
12 Dessert Forks / Tenedores para Postre  
12 Dessert Knives / Cuchillos para Postre  
12 Tea Spoons / Cucharas para Té  
12 Coffee Spoons / Cucharas para Café  
1 Soup Ladle / Cazo para Sopa  
1 Serving Spoon / Cuchara para Servir  
1 Sugar Spoon / Cuchara para Azúcar  
1 Salad Spoon / Cuchara para Ensalada  
1 Salad Fork / Tenedor para Ensalada



**FLATWARE SET  
JUEGO DE CUBIERTOS  
130 PC./PZAS.  
Solid handle knives 6mm  
Cuchillos forjados 6mm**

	Ref.	Un.	m <sup>3</sup>	7891116
Italy	66932/227	01	0,043	150689
Mônaco	66917/227	01	0,043	150665

**Contents | Contenido:**

12 Table Spoons / Cucharas de Mesa  
12 Table Forks / Tenedores de Mesa  
12 Table Knives / Cuchillos de Mesa  
12 Dessert Spoons / Cucharas para Postre  
12 Dessert Forks / Tenedores para Postre  
12 Dessert Knives / Cuchillos para Postre  
12 Tea Spoons / Cucharas para Té  
12 Coffee Spoons / Cucharas para Café  
1 Soup Ladle / Cazo para Sopa  
1 Serving Spoon / Cuchara para Servir  
1 Sugar Spoon / Cuchara para Azúcar  
1 Salad Spoon / Cuchara para Ensalada  
1 Salad Fork / Tenedor para Ensalada  
1 Carving Knife / Cuchillo Trinchant para Carne  
1 Carving Fork / Tenedor Trinchant para Carne  
1 Sauce Ladle / Cazo de Salsa Pequeño  
12 Fish Forks / Tenedores para Pescado  
12 Fish Knives / Cuchillos para Pescado  
1 Fish Knife / Cuchillo Trinchant para Pescado  
1 Fish Fork / Tenedor Trinchant para Pescado



FLATWARE SET  
JUEGO DE CUBIERTOS  
76 PC./PZAS.

	Ref.	Un.	m <sup>3</sup>	7891116
Maresias	66902/300	01	0,014	056295
Cosmos	66950/307	01	0,014	072707
Athenas	66940/307	01	0,014	072691
Amazonas	66960/300	01	0,015	057315
Laguna	66906/300	01	0,014	048375

Contents / Contenido:  
 12 Table Spoons / Cucharas de Mesa  
 12 Table Forks / Tenedores de Mesa  
 12 Table Knives / Cuchillos de Mesa  
 12 Dessert Spoons / Cucharas para Postre  
 12 Coffee Spoons / Cucharas para Café  
 1 Sugar Spoon / Cuchara para Azúcar  
 1 Salad Spoon / Cuchara para Ensalada  
 1 Salad Fork / Tenedor para Ensalada  
 12 Cake Forks / Tenedores para Pastel  
 1 Cake Server / Espátula para Pastel



SERVICE  
SERVICIO

12

PEOPLE  
PERSONAS

FLATWARE SET  
JUEGO DE CUBIERTOS  
72 PC./PZAS.

	Ref.	Un.	m <sup>3</sup>	7891116
Berlin	66934/150	01	0,023	079638
	66934/154*	01	0,023	084090
Oslo	66985/150	01	0,023	090046
	66985/154*	01	0,023	091180
Pacific	66962/150	01	0,023	079621
	66962/154*	01	0,023	084106
Amazonas	66960/150	01	0,023	150986
	66960/153*	01	0,023	150993

Solid handle knives 6mm  
Cuchillos forjados 6mm

	Ref.	Un.	m <sup>3</sup>	7891116
Italy	66932/150	01	0,023	031513
	66932/157*	01	0,023	147856
Mônaco	66917/150	01	0,023	031452
	66917/157*	01	0,023	147825

Contents / Contenido:  
 12 Table Spoons / Cucharas de Mesa  
 12 Table Forks / Tenedores de Mesa  
 12 Table Knives / Cuchillos de Mesa  
 12 Tea Spoons / Cucharas para Té  
 12 Coffee Spoons / Cucharas para Café  
 12 Cake Forks / Tenedores para Pastel

\* Steak Knife / Cuchillo para Asado



SERVICE  
SERVICIO

8

PEOPLE  
PERSONAS

FLATWARE SET  
JUEGO DE CUBIERTOS  
48 PC./PZAS.

	Ref.	Un.	m <sup>3</sup>	7891116
Berlin	66934/140	01	0,017	079607
	66934/144*	01	0,017	084052
Oslo	66985/140	01	0,017	090039
	66985/144*	01	0,017	091173
Pacific	66962/140	01	0,017	079591
	66962/144*	01	0,017	084069
Amazonas	66960/140	01	0,014	150863
	66960/144*	01	0,014	150870

Solid handle knives 6mm  
Cuchillos forjados 6mm

	Ref.	Un.	m <sup>3</sup>	7891116
Italy	66932/140	01	0,014	150900
	66932/144*	01	0,014	150917
Mônaco	66917/140	01	0,014	150924
	66917/144*	01	0,014	150931

Contents / Contenido:  
8 Table Spoons / Cucharas de Mesa  
8 Table Forks / Tenedores de Mesa  
8 Table Knives / Cuchillos de Mesa  
8 Tea Spoons / Cucharas para Té  
8 Coffee Spoons / Cucharas para Café  
8 Cake Forks / Tenedores para Pastel

FLATWARE SET  
JUEGO DE CUBIERTOS  
36 PC./PZAS.

	Ref.	Un.	m <sup>3</sup>	7891116
Berlin	66934/130	01	0,013	079553
	66934/134*	01	0,013	084014
Oslo	66985/130	01	0,013	090022
	66985/134*	01	0,013	091166
Pacific	66962/130	01	0,013	081389
	66962/134*	01	0,013	084021
Amazonas	66960/130	01	0,013	150771
	66960/134*	01	0,013	150788

Solid handle knives 6mm  
Cuchillos forjados 6mm

	Ref.	Un.	m <sup>3</sup>	7891116
Italy	66932/130	01	0,013	150818
	66932/134*	01	0,013	150825
Mônaco	66917/130	01	0,013	150832
	66917/134*	01	0,013	150849

Contents / Contenido:  
6 Table Spoons / Cucharas de Mesa  
6 Table Forks / Tenedores de Mesa  
6 Table Knives / Cuchillos de Mesa  
6 Tea Spoons / Cucharas para Té  
6 Coffee Spoons / Cucharas para Café  
6 Cake Forks / Tenedores para Pastel



SERVICE  
SERVICIO

6

PEOPLE  
PERSONAS

\* Steak Knife / Cuchillo para Asado





SERVICE  
SERVICIO

**4**

PEOPLE  
PERSONAS

FLATWARE SET  
JUEGO DE CUBIERTOS  
24 PC./PZAS.

	Ref.	Un.	m <sup>3</sup>	7891116
Berlin	66934/120	02	0,020	079508
	66934/124*	02	0,020	083970
Oslo	66985/120	02	0,020	090015
	66985/124*	02	0,020	091159
Pacific	66962/120	02	0,020	079492
	66962/124*	02	0,020	083987
Amazonas	66960/120	02	0,020	150696
	66960/124*	02	0,020	150702

Solid handle knives 6mm  
Cuchillos forjados 6mm

	Ref.	Un.	m <sup>3</sup>	7891116
Italy	66932/120	02	0,020	150733
	66932/124*	02	0,020	150740
Mônaco	66917/120	01	0,020	150757
	66917/124*	01	0,020	150764

Contents / Contenido:

4 Table Spoons / Cucharas de Mesa  
4 Table Forks / Tenedores de Mesa  
4 Table Knives / Cuchillos de Mesa  
4 Tea Spoons / Cucharas para Té  
4 Coffee Spoons / Cucharas para Café  
4 Cake Forks / Tenedores para Pastel



UTENSIL SET  
JUEGO DE UTENSILIOS  
4 PC./PZAS.

	Ref.	Un.	m <sup>3</sup>	7891116
Berlin	66934/160	06	0,027	079683
Pacific	66962/160	06	0,027	079676
Mônaco	66917/160	06	0,027	151075
Italy	66932/160	06	0,027	151068
Oslo	66985/160	06	0,027	090053
Amazonas	66960/160	06	0,027	151044

Contents / Contenido:

1 Serving Spoon / Cuchara para Servir  
1 Cake Server / Espátula para Pastel  
1 Salad Spoon / Cuchara para Ensalada  
1 Salad Fork / Tenedor para Ensalada



SPAGHETTI SET  
JUEGO PARA PASTA  
8 PC./PZAS.

	Ref.	Un.	m <sup>3</sup>	7891116
	66934/610	06	0,027	080603

Contents / Contenido:

4 Forks / Tenedores  
4 Spoons / Cucharas

\* Steak Knife / Cuchillo para Asado



**FLATWARE SET  
JUEGO DE CUBIERTOS  
16 PC./PZAS.**

	Ref.	Un.	m <sup>3</sup>	7891116
Havái	66905/080	06	0,008	168943
	66905/084*	06	0,008	168950

Contents / Contenido:  
 4 Table Spoons / Cucharas de Mesa  
 4 Table Forks / Tenedores de Mesa  
 4 Table Knives / Cuchillos de Mesa  
 4 Tea Spoons / Cucharas para Té



**FLATWARE SET  
JUEGO DE CUBIERTOS  
24 PC./PZAS.**

	Ref.	Un.	m <sup>3</sup>	7891116
Havái	66905/090	06	0,008	165973
	66905/094*	06	0,008	165980

Contents / Contenido:  
 6 Table Spoons / Cucharas de Mesa  
 6 Table Forks / Tenedores de Mesa  
 6 Table Knives / Cuchillos de Mesa  
 6 Tea Spoons / Cucharas para Té

NEW RELEASE  
LANZAMIENTO



**FLATWARE SET  
JUEGO DE CUBIERTOS  
16 PC./PZAS.**

	Ref.	Un.	m <sup>3</sup>	7891116
Havái	66905/550	10	0,045	166116
	66905/554*	10	0,045	166123

Contents / Contenido:  
 4 Table Spoons / Cucharas de Mesa  
 4 Table Forks / Tenedores de Mesa  
 4 Table Knives / Cuchillos de Mesa  
 4 Tea Spoons / Cucharas para Té



**FLATWARE SET  
JUEGO DE CUBIERTOS  
36 PC./PZAS.**

	Ref.	Un.	m <sup>3</sup>	7891116
Havái	66905/130	05	0,037	169469

Contents / Contenido:  
 6 Table Spoons / Cucharas de Mesa  
 6 Table Forks / Tenedores de Mesa  
 6 Steak Knives / Cuchillos para Asado  
 6 Tea Spoons / Cucharas para Té  
 6 Coffee Spoons / Cucharas para Café  
 6 Cake Forks / Tenedores para Pastel



**FLATWARE SET  
JUEGO DE CUBIERTOS  
72 PC./PZAS.**

	Ref.	Un.	m <sup>3</sup>	7891116
Havaí	66905/150	06	0,056	169476

Contents / Contenido:  
 12 Table Spoons / Cucharas de Mesa  
 12 Table Forks / Tenedores de Mesa  
 12 Steak Knives / Cuchillos para Asado  
 12 Tea Spoons / Cucharas para Té  
 12 Coffee Spoons / Cucharas para Café  
 12 Cake Forks / Tenedores para Pastel



**CAKE SET  
JUEGO DE PASTEL  
13 PC./PZAS.**

	Ref.	Un.	m <sup>3</sup>	7891116
Maresias	66902/610	12	0,024	046142
Laguna	66906/610	12	0,024	028476

Contents / Contenido:  
 12 Cake Forks / Tenedores para Pastel  
 1 Cake Server / Espátula para Pastel



**STEAK SET  
JUEGO DE ASADO  
12 PC./PZAS.**

	Ref.	Un.	m <sup>3</sup>	7891116
Laguna	66906/630	10	0,037	028681
Athenas	66940/647	10	0,031	072745
Cosmos	66950/637	10	0,031	072752

Contents / Contenido:  
 6 Table Forks / Tenedores de Mesa  
 6 Steak Knives / Cuchillos para Asado



**FLATWARE SET  
JUEGO DE CUBIERTOS  
24 PC./PZAS.**

	Ref.	Un.	m <sup>3</sup>	7891116
Havana	66945/000	10	0,055	139509
	66945/840*	10	0,055	139516
Maresias	66902/000	10	0,055	045893
	66902/840*	10	0,055	062432
Laguna	66906/010	10	0,055	013052
	66906/840*	10	0,055	062449
Athenas	66940/007	10	0,061	072592
	66940/847*	10	0,061	072615
Cosmos	66950/017	10	0,061	072608
	66950/847*	10	0,061	072622
Pacific	66962/970	08	0,045	066133

Contents / Contenido:  
 6 Table Spoons / Cucharas de Mesa  
 6 Table Forks / Tenedores de Mesa  
 6 Table Knives / Cuchillos de Mesa  
 6 Tea Spoons / Cucharas para Té

\* Steak Knife / Cuchillo para Asado





FLATWARE SET  
JUEGO DE CUBIERTOS  
24 PC./PZAS.

	Ref.	Un.	m <sup>3</sup>	7891116
Havana	66945/050	04	0,020	139523
	66945/054*	04	0,020	139530

Contents / Contenido:  
6 Table Spoons / Cucharas de Mesa  
6 Table Forks / Tenedores de Mesa  
6 Table Knives / Cuchillos de Mesa  
6 Tea Spoons / Cucharas para Té



FLATWARE SET  
JUEGO DE CUBIERTOS  
36 PC./PZAS.

	Ref.	Un.	m <sup>3</sup>	7891116
Havana	66945/790	05	0,048	144046
	66945/794*	05	0,048	144053
Laguna	66906/790	05	0,067	083833
	66906/794*	05	0,048	084168
Pacific	66962/930	05	0,083	070352

Contents / Contenido:  
6 Table Spoons / Cucharas de Mesa  
6 Table Forks / Tenedores de Mesa  
6 Table Knives / Cuchillos de Mesa  
6 Tea Spoons / Cucharas para Té  
6 Coffee Spoons / Cucharas para Café  
6 Cake Forks / Tenedores para Pastel



FLATWARE SET  
JUEGO DE CUBIERTOS  
42 PC./PZAS.

	Ref.	Un.	m <sup>3</sup>	7891116
Havana	66945/770	05	0,071	144060
	66945/774*	05	0,071	144077
Laguna	66906/770	05	0,071	066454
	66906/774*	05	0,071	066461
Cosmos	66950/770	05	0,083	088821
	66950/774*	05	0,083	088838
Athenas	66940/770	05	0,083	123782
	66940/774*	05	0,083	123799
Pacific	66962/770	05	0,077	116227
	66962/774*	05	0,077	116234

Contents / Contenido:  
6 Table Spoons / Cucharas de Mesa  
6 Table Forks / Tenedores de Mesa  
6 Table Knives / Cuchillos de Mesa  
6 Dessert Spoons / Cucharas para Postre  
6 Tea Spoons / Cucharas para Té  
6 Coffee Spoons / Cucharas para Café  
6 Cake Forks / Tenedores para Pastel



**FLATWARE SET  
JUEGO DE CUBIERTOS  
48 PC./PZAS.**

	Ref.	Un.	m <sup>3</sup>	7891116
Angra	66903/140	05	0,071	125144
	66903/144*	05	0,071	125151

Contents / Contenido:  
 8 Table Spoons / Cucharas de Mesa  
 8 Table Forks / Tenedores de Mesa  
 8 Table Knives / Cuchillos de Mesa  
 8 Tea Spoons / Cucharas para Té  
 8 Coffee Spoons / Cucharas para Café  
 8 Cake Forks / Tenedores para Pastel



**FLATWARE SET  
JUEGO DE CUBIERTOS  
60 PC./PZAS.**

	Ref.	Un.	m <sup>3</sup>	7891116
Laguna	66906/780	06	0,099	070345
	66906/784*	06	0,099	070413

Contents / Contenido:  
 12 Table Spoons / Cucharas de Mesa  
 12 Table Forks / Tenedores de Mesa  
 12 Table Knives / Cuchillos de Mesa  
 12 Dessert Spoons / Cucharas para Postre  
 12 Coffee Spoons / Cucharas para Café



**FLATWARE SET  
JUEGO DE CUBIERTOS  
72 PC./PZAS.**

	Ref.	Un.	m <sup>3</sup>	7891116
Angra	66903/150	06	0,099	125168
	66903/154*	06	0,099	125175

Contents / Contenido:  
 12 Table Spoons / Cucharas de Mesa  
 12 Table Forks / Tenedores de Mesa  
 12 Table Knives / Cuchillos de Mesa  
 12 Tea Spoons / Cucharas para Té  
 12 Coffee Spoons / Cucharas para Café  
 12 Cake Forks / Tenedores para Pastel



**FLATWARE SET  
JUEGO DE CUBIERTOS  
76 PC./PZAS.**

	Ref.	Un.	m <sup>3</sup>	7891116
Havana	66945/824	04	0,108	144732

Contents / Contenido:  
 12 Table Spoons / Cucharas de Mesa  
 12 Table Forks / Tenedores de Mesa  
 12 Steak Knives / Cuchillos para Asado  
 12 Tea Spoons / Cucharas para Té  
 12 Coffee Spoons / Cucharas para Café  
 12 Cake Forks / Tenedores para Pastel  
 1 Salad Spoon / Cuchara para Ensalada  
 1 Salad Fork / Tenedor para Ensalada  
 1 Serving Spoon / Cuchara para Servir  
 1 Spaghetti Tong / Pinza para Pasta



**FLATWARE SET  
JUEGO DE CUBIERTOS  
79 PC./PZAS.**

	Ref.	Un.	m <sup>3</sup>	7891116
Angra	66903/694	04	0,118	125182

Contents / Contenido:  
 12 Table Spoons / Cucharas de Mesa  
 12 Table Forks / Tenedores de Mesa  
 12 Steak Knives / Cuchillos para Asado  
 12 Dessert Spoons / Cucharas para Postre  
 12 Coffee Spoons / Cucharas para Café  
 12 Cake Forks / Tenedores para Pastel  
 1 Serving Spoon / Cuchara para Servir  
 1 Cake Server / Espátula para Pastel  
 1 Ladle / Cazo Mediano  
 1 Salad Spoon / Cuchara para Ensalada  
 1 Salad Fork / Tenedor para Ensalada  
 1 Carving fork / Tenedor Trinchante  
 1 Spaghetti Tong / Pinza para Pasta



**FLATWARE SET  
JUEGO DE CUBIERTOS  
84 PC./PZAS.**

	Ref.	Un.	m <sup>3</sup>	7891116
Cosmos	66950/520	04	0,101	075906

Contents / Contenido:  
 12 Table Spoons / Cucharas de Mesa  
 12 Table Forks / Tenedores de Mesa  
 12 Steak Knives / Cuchillos para Asado  
 12 Dessert Spoons / Cucharas para Postre  
 12 Tea Spoons / Cucharas para Té  
 12 Coffee Spoons / Cucharas para Café  
 12 Cake Forks / Tenedores para Pastel





**FLATWARE SET  
JUEGO DE CUBIERTOS  
91 PC./PZAS.**

	Ref.	Un.	m <sup>3</sup>	7891116
Laguna	66906/890	04	0,118	066485

**Contents / Contenido:**

- 12 Table Spoons / Cucharas de Mesa
- 12 Table Forks / Tenedores de Mesa
- 12 Steak Knives / Cuchillos para Asado
- 12 Dessert Spoons / Cucharas para Postre
- 12 Tea Spoons / Cucharas para Té
- 12 Coffee Spoons / Cucharas para Café
- 1 Serving Spoon / Cuchara para Servir
- 12 Cake Forks / Tenedores para Pastel
- 1 Cake Server / Espátula para Pastel
- 1 Ladle / Cazo Mediano
- 1 Salad Spoon / Cuchara para Ensalada
- 1 Salad Fork / Tenedor para Ensalada
- 1 Carving Fork / Tenedor Trinchante
- 1 Spaghetti Tong / Pinza para Pasta



**FLATWARE SET  
JUEGO DE CUBIERTOS  
101 PC./PZAS.**

	Ref.	Un.	m <sup>3</sup>	7891116
Athenas	66940/027	04	0,118	072677
Cosmos	66950/027	04	0,118	072684

**Contents / Contenido:**

- 12 Table Spoons / Cucharas de Mesa
- 12 Table Forks / Tenedores de Mesa
- 12 Table Knives / Cuchillos de Mesa
- 12 Dessert Spoons / Cucharas para Postre
- 12 Dessert Forks / Tenedores para Postre
- 12 Dessert Knives / Cuchillos para Postre
- 12 Tea Spoons / Cucharas para Té
- 12 Coffee Spoons / Cucharas para Café
- 1 Soup Ladle / Cazo para Sopa
- 1 Serving Spoon / Cuchara para Servir
- 1 Sugar Spoon / Cuchara para Azúcar
- 1 Salad Spoon / Cuchara para Ensalada
- 1 Salad Fork / Tenedor para Ensalada

# Essentials



Created to make the life easier, the Essentials collection brings the most varied utensils that enhance the pleasure of cooking, preparing and serving. They are tongs, forks, knives, spoons and more - all with the shine of stainless steel and design that makes it beautiful in every household task.

Stainless Steel Versatility

Creada para hacer la vida más fácil, la colección Essentials ofrece los más variados utensilios que mejoran el placer de cocinar, preparar y servir. Son pinzas, tenedores, cuchillos, cucharas y más, todo con el brillo del acero inoxidable y un diseño que lo hace hermoso en cada tarea del hogar.

Acero Inoxidable Versatilidad







**TEA SPOONS SET**  
**JUEGO DE CUCHARAS PARA TÉ**  
**3 PC./PZAS.**

Ref.	Un.	m <sup>3</sup>	7891116
66960/017	12	0,005	157633

Contents / Contenido:  
 3 Table Spoons / Cucharas de Mesa



**FORKS SET**  
**JUEGO DE TENEDORES DE MESA**  
**3 PC./PZAS.**

Ref.	Un.	m <sup>3</sup>	7891116
66960/027	12	0,005	157640

Contents / Contenido:  
 3 Table Forks / Tenedores de Mesa



**KNIVES SET**  
**JUEGO DE CUCHILLOS DE MESA**  
**3 PC./PZAS.**

Ref.	Un.	m <sup>3</sup>	7891116
66960/037	12	0,004	157657

Contents / Contenido:  
 3 Table Knives / Cuchillos de Mesa



**DESSERT SPOONS SET**  
**JUEGO DE CUCHARAS PARA POSTRE**  
**3 PC./PZAS.**

Ref.	Un.	m <sup>3</sup>	7891116
66960/047	12	0,005	160022

Contents / Contenido:  
 3 Dessert Spoons / Cucharas para Postre



**COCKTAIL SPOON**  
**CUCHARA PARA COQUETEL**  
**1 PC./PZAS.**

Ref.	Un.	m <sup>3</sup>	7891116
63960/520	12	0,006	156674



**TEA SET  
JUEGO PARA TÉ  
6 PC./PZAS.**

Ref.	Un.	m <sup>3</sup>	7891116
63960/077	12	0,002	148747

Contents / Contenido:  
6 Tea Spoons / Cucharas para Té



**COFFEE / ESPRESSO SPOON SET  
JUEGO DE CUCHARAS PARA CAFÉ /  
EXPRESO  
6 PC./PZAS.**

Ref.	Un.	m <sup>3</sup>	7891116
66960/510	12	0,002	149980

Contents / Contenido:  
6 Coffee / Espresso Spoons  
Cucharas para Café / Expreso



**COFFEE/ESPRESSO SPOONS SET  
JUEGO DE CUCHARAS PARA CAFÉ/  
EXPRESO  
6 PC./PZAS.**

Ref.	Un.	m <sup>3</sup>	7891116
66999/513	12	0,001	149997

Contents / Contenido:  
6 Coffee / Espresso Spoons  
Cucharas para Café / Expreso



**LATTE SPOONS SET  
JUEGO DE CUCHARAS PARA LATTE  
6 PC./PZAS.**

Ref.	Un.	m <sup>3</sup>	7891116
66960/810	12	0,003	149966

Contents / Contenido:  
6 Latte Spoons / Cucharas para Latte



**CAKE FORKS SET  
JUEGO DE TENEDORES PARA PASTEL  
6 PC./PZAS.**

Ref.	Un.	m <sup>3</sup>	7891116
63960/147	12	0,002	148778

Contents / Contenido:  
6 Cake Forks / Tenedores de Pastel



**CAKE SERVER  
ESPÁTULA PARA PASTEL**

Ref.	Un.	m <sup>3</sup>	7891116
63960/157	12	0,005	148785

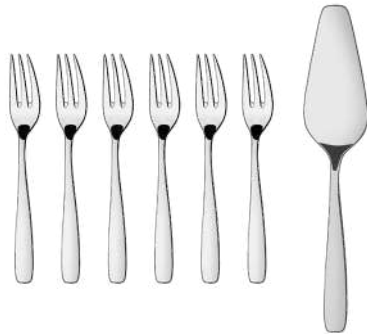

**CAKE SET  
JUEGO PARA PASTEL  
7 PC./PZAS.**

Ref.	Un.	m <sup>3</sup>	7891116
66960/607	12	0,005	148754

Contents / Contenido:  
1 Cake Server / Espátula para Pastel  
6 Cake Forks / Tenedores de Pastel



**CAKE SET  
JUEGO PARA PASTEL  
2 PC./PZAS.**

Ref.	Un.	m <sup>3</sup>	7891116
66960/583	12	0,005	150016

Contents / Contenido:  
1 Cake Server / Espátula para Pastel  
1 Cake Knife / Cuchillo para Pastel



**BUTTER KNIVES SET  
JUEGO DE ESPÁTULAS PARA  
MANTEQUILLA  
6 PC./PZAS.**

Ref.	Un.	m <sup>3</sup>	7891116
63960/247	12	0,002	148846

Contents / Contenido:  
6 Butter Knives / Espátulas para mantequilla



**ICE CREAM SPOONS SET  
JUEGO DE CUCHARAS PARA HELADO  
6 PC./PZAS.**

Ref.	Un.	m <sup>3</sup>	7891116
63960/117	12	0,002	148792

Contents / Contenido:  
6 Ice Cream Spoons / Cucharas para Helado





**FRUIT KNIVES SET**  
**JUEGO DE CUCHILLOS PARA FRUTAS**  
**2 PC./PZAS.**

Ref.	Un.	m <sup>3</sup>	7891116
66960/533	12	0,003	150061

Contents / Contenido:  
 2 Fruit Knives / Cuchillos para Frutas



**FRUIT SET**  
**JUEGO PARA FRUTAS**  
**2 PC./PZAS.**

Ref.	Un.	m <sup>3</sup>	7891116
66960/573	12	0,002	150054

Contents / Contenido:  
 1 Fruit Fork / Tenedor para Frutas  
 1 Fruit Knife / Cuchillo para Frutas



**SOUP SPOONS SET**  
**JUEGO DE CUCHARAS PARA SOPA**  
**6 PC./PZAS.**

Ref.	Un.	m <sup>3</sup>	7891116
63960/287	12	0,005	148808

Contents / Contenido:  
 6 Soup Spoons / Cucharas para Sopa



**STEAK SET**  
**JUEGO PARA ASADO**  
**2 PC./PZAS.**

Ref.	Un.	m <sup>3</sup>	7891116
66960/917	12	0,005	148761

Contents / Contenido:  
 1 Steak Fork / Tenedor para Asado  
 1 Steak Knife / Cuchillo para Asado

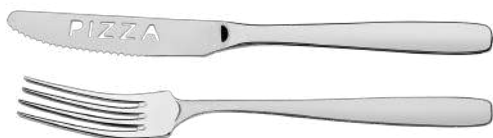

**PIZZA SET**  
**JUEGO PARA PIZZA**  
**2 PC./PZAS.**

Ref.	Un.	m <sup>3</sup>	7891116
66960/543	12	0,005	150047

Contents / Contenido:  
 1 Pizza Fork / Tenedor para Pizza  
 1 Pizza Knife / Cuchillo para Pizza





**SPAGHETTI SET  
JUEGO PARA SPAGHETTI  
2 PC./PZAS.**

Ref.	Un.	m <sup>3</sup>	7891116
66934/593	06	0,003	150030

Contents / Contenido:  
1 Spaghetti Fork / Tenedor para Spaghetti  
1 Spaghetti Spoon / Cuchara para Spaghetti



**APPETIZER FORKS SET  
JUEGO DE TENEDORES PARA APERITIVO  
6 PC./PZAS.**

Ref.	Un.	m <sup>3</sup>	7891116
66960/740	12	0,002	149973

Contents / Contenido:  
6 Appetizer Forks / Tenedores para Aperitivo



**SERVING SPOON  
CUCHARA PARA SERVIR**

Ref.	Un.	m <sup>3</sup>	7891116
63960/107	12	0,007	148815

**PACKAGING  
EMBALAJES**





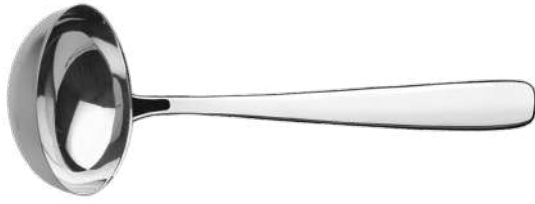

SOUP LADLE  
CAZO PARA SOPA

Ref.	Un.	m <sup>3</sup>	7891116
63960/097	12	0,030	148822



SAUCE LADLE  
CAZO DE SALSA PEQUEÑO

Ref.	Un.	m <sup>3</sup>	7891116
63960/217	12	0,007	148839



SALAD SET  
JUEGO PARA ENSALADA  
2 PC./PZAS.

Ref.	Un.	m <sup>3</sup>	7891116
63960/127	12	0,003	148853

Contents / Contenido:  
1 Salad Fork / Tenedor para Ensalada  
1 Salad Spoon / Cuchara para Ensalada

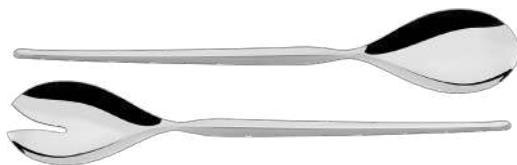

SALAD SET  
JUEGO PARA ENSALADA  
2 PC./PZAS.

Ref.	Un.	m <sup>3</sup>	7891116
66999/607	12	0,007	148907

Contents / Contenido:  
1 Salad Fork / Tenedor para Ensalada  
1 Salad Spoon / Cuchara para Ensalada



BREAD KNIFE  
CUCHILLO PARA PAN

Ref.	Un.	m <sup>3</sup>	7891116
63960/163	12	0,005	150009



**SPAGHETTI TONG  
PINZA PARA PASTA**

Ref.	Un.	m <sup>3</sup>	7891116
63800/607	12	0,009	008157



**UTILITY TONG  
PINZA UNIVERSAL**

Ref.	Un.	m <sup>3</sup>	7891116
63800/627	12	0,009	008164

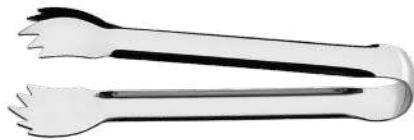

**ICE TONG  
PINZA PARA HIELO**

Ref.	Un.	m <sup>3</sup>	7891116
63800/647	12	0,007	148730



**BARBECUE TONG  
PINZA PARA ASADO**

Ref.	Un.	m <sup>3</sup>	7891116
63800/687	12	0,002	148877



**SALAD TONG  
PINZA PARA ENSALADA**

Ref.	Un.	m <sup>3</sup>	7891116
63800/847	12	0,020	148884



WHISKY MEASURE  
MEDIDOR PARA WHISKY

Ref.	Un.	m <sup>3</sup>	7891116
61102/007	12	0,005	148938



TOOTHPICK HOLDER  
PALILLERO

Ref.	Un.	m <sup>3</sup>	7891116
61105/007	12	0,006	148914















NAPKIN HOLDER  
PORTA SERVILLETAS

Ref.	Un.	m <sup>3</sup>	7891116
61216/127	12	0,006	148921



















# SKIN PACK | BLISTER SKIN

ATHENAS | COSMOS | AMAZONAS

Ref.	Un.	m <sup>3</sup>	7891116	Information/Información	Illustration/Ilustración
66940/011			003381	3 pc. Table Spoons   Cucharas de Mesa 3 pzas.	
66950/011	120	0,099	002858		
66960/011			089828		
66940/021			003398	3 pc. Table Forks   Tenedores de Mesa 3 pzas.	
66950/021	120	0,099	002872		
66960/021			089835		
66940/031			003404	3 pc. Table Knives   Cuchillos de Mesa 3 pzas.	
66950/031	120	0,037	002896		
66960/031			089842		
66940/041			003442	3 pc. Dessert Spoons   Cucharas de Postre 3 pzas.	
66950/041	120	0,099	002971		
66960/041			089859		
66940/051			003459	3 pc. Dessert Forks   Tenedores de Postre 3 pzas.	
66950/051	120	0,061	002995		
66960/051			089866		
66940/061			003466	3 pc. Dessert Knives   Cuchillos de Postre 3 pzas.	
66950/061	120	0,037	003015		
66960/061			089873		
66940/071			034262	6 pc. Tea Spoons   Cucharas para Té 6 pzas.	
66950/071	120	0,099	034279		
66960/071			089880		
66940/081			003435	6 pc. Coffee Spoons   Cucharas para Café 6 pzas.	
66950/081	120	0,061	002957		
66960/081			089897		
66940/111			009437	6 pc. Sugar Spoons   Cucharas para Azúcar 6 pzas.	
66950/111	120	0,099	009444		
66960/111			106259		
66940/121			003480	2 pc. Salad set   Juego para ensalada 2 pzas.	
66950/121	120	0,099	003053		
66960/121			106266		
66940/141			003497	6 pc. Cake Forks   Tenedores para Pastel 6 pzas.	
66950/141	120	0,061	003084		
66960/141			106273		
66940/181			010068	3 pc. Steak Knives   Cuchillos de Asado 3 pzas.	
66950/181	120	0,037	010037		
66960/181			089903		
66960/241	120	0,061	106280	6 pc. Butter Spreaders   Espátulas para Mantequilla 6 pzas.	

# HANG-TAG PACKAGING | BLISTER

ATHENAS | COSMOS | AMAZONAS

Ref.	Un.	m <sup>3</sup>	7891116	Information/Información	Illustration/Ilustración
66940/015			026182		
66950/015	120	0,031	037737	3 pc. Table Spoons   Cucharas de Mesa 3 pzas.	
66960/015			095522		
66940/025			026199		
66950/025	120	0,031	037751	3 pc. Table Forks   Tenedores de Mesa 3 pzas.	
66960/025			095539		
66940/035			026205		
66950/035	120	0,037	037768	3 pc. Table Knives   Cuchillos de Mesa 3 pzas.	
66960/035			095546		
66950/045	120	0,031	044223	3 pc. Dessert Spoons   Cucharas de Postre 3 pzas.	
66960/045			095553		
66950/055	120	0,031	038246	3 pc. Dessert Forks   Tenedores de Postre 3 pzas.	
66960/055			095560		
66950/065	120	0,031	044230	3 pc. Dessert Knives   Cuchillos de Postre 3 pzas.	
66960/065			095577		
66940/075			043035		
66950/075	120	0,020	777772	6 pc. Tea Spoons   Cucharas para Té 6 pzas.	
66960/075			095584		
66940/085			041246		
66950/085	120	0,020	037744	6 pc. Coffee Spoons   Cucharas para Café 6 pzas.	
66960/085			095591		
66960/115	120	0,020	106198	6 pc. Sugar Spoons   Cucharas para Azúcar 6 pzas.	
66950/145	120	0,020	037782	6 pc. Cake Forks   Tenedores para Pastel 6 pzas.	
66960/145			106204		
66940/185			046777		
66950/185	120	0,037	037799	3 pc. Steak Knives   Cuchillos para Asado 3 pzas.	
66960/185			095607		
66960/505	120	0,020	119389	6 pc. Butter Spreaders Espátulas para Mantequilla 6 pzas.	
63940/091			003350		
63950/091	48	0,026	002773	1 pc. Soup Ladle   Cazo para Sopa 1 pza.	
63960/091			106211		
63940/101			003367		
63950/101	48	0,015	002797	1 pc. Serving Spoon   Cuchara para Servir 1 pza.	
63960/101			106228		
63960/125	48	0,014	119402	2 pc. Salad Set Juego para Ensalada 2 pzas.	
63940/151			014288		
63950/151	48	0,015	014295	1 pc. Cake Server   Espátula para Pastel 1 pza.	
63960/151			106235		
63960/161	24	0,002	149249	1 pc. Bread Knife   Cuchillo para Pan 1 pza.	
63940/191			003374		
63950/191	48	0,018	002827	1 pc. Ladle   Cazo Mediano 1 pza.	
63940/211			010877		
63950/211	48	0,014	010884	1 pc. Sauce Ladle   Cazo de Salsa Pequeño 1 pza.	
63960/211			106242		
63950/471	48	0,015	048610	1 pc. Carving Fork   Tenedor 1 pza.	

## OSLO

Ref.	Un.	m <sup>3</sup>	7891116	Information/Información	Illustration/Ilustración
66985/015	12	0,004	156322	3 pc. Table Spoons   Cucharas de Mesa 3 pzas.	
66985/025	12	0,004	156339	3 pc. Table Forks   Tenedores de Mesa 3 pzas.	
66985/035	12	0,003	156346	2 pc. Table Knives   Cuchillos de Mesa 2 pzas.	
66985/075	12	0,003	156353	6 pc. Dessert Spoons   Cucharas de Té 6 pzas.	
66985/085	12	0,002	156360	6 pc. Coffee Spoons   Cucharas para Café 6 pzas.	
66985/185	12	0,002	156377	2 pc. Steak Knives   Cuchillos de Asado 2 pzas.	





**FLATWARE SET  
JUEGO DE CUBIERTOS  
24 PC./PZAS.  
AMAZONAS**

	Ref.	Un.	m <sup>3</sup>	7891116
	66960/976	12	0,038	106174
	66960/846*	12	0,038	106181

6 units per display box / Caja display con 6 unidades  
12 units per master box / Caja master con 12 unidades

Contents / Contenido:  
6 Table Spoons / Cucharas de Mesa  
6 Table Forks / Tenedores de Mesa  
6 Table Knives / Cuchillos de Mesa  
6 Tea Spoons / Cucharas para Té



**FLATWARE SET  
JUEGO DE CUBIERTOS  
16 PC./PZAS.**

	Ref.	Un.	m <sup>3</sup>	7891116
Amazonas	66960/550	10	0,045	106617
	66960/554*	10	0,045	106624
Oslo	66985/550	10	0,045	156285
	66985/554*	10	0,045	156292

Contents / Contenido:  
4 Table Spoons / Cucharas de Mesa  
4 Table Forks / Tenedores de Mesa  
4 Table Knives / Cuchillos de Mesa  
4 Tea Spoons / Cucharas para Té

\* Steak Knife / Cuchillo para Asado



**FLATWARE SET  
JUEGO DE CUBIERTOS  
20 PC./PZAS.**

	Ref.	Un.	m <sup>3</sup>	7891116
Amazonas	66960/760	04	0,026	138700

Contents / Contenido:  
4 Table Spoons / Cucharas de Mesa  
4 Table Forks / Tenedores de Mesa  
4 Dessert Spoons / Cucharas para Postre  
4 Dessert Forks / Tenedores para Postre





FLATWARE SET  
JUEGO DE CUBIERTOS  
24 PC./PZAS.

	Ref.	Un.	m <sup>3</sup>	7891116
Cosmos	66950/000	10	0,020	012635
	66950/014*	10	0,020	035184
Amazonas	66960/010	10	0,020	106150
	66960/014*	10	0,020	106167

Contents / Contenido:  
6 Table Spoons / Cucharas de Mesa  
6 Table Forks / Tenedores de Mesa  
6 Table Knives / Cuchillos de Mesa  
6 Tea Spoons / Cucharas para Té



FLATWARE SET  
JUEGO DE CUBIERTOS  
24 PC./PZAS.

	Ref.	Un.	m <sup>3</sup>	7891116
Amazonas	66960/005	10	0,045	090817
	66960/004*	10	0,045	090800
Oslo	66985/005	10	0,045	156308
	66985/004*	10	0,045	156315

Contents / Contenido:  
6 Table Spoons / Cucharas de Mesa  
6 Table Forks / Tenedores de Mesa  
6 Table Knives / Cuchillos de Mesa  
6 Tea Spoons / Cucharas para Té



















FLATWARE SET  
JUEGO DE CUBIERTOS  
24 PC./PZAS.  
AMAZONAS

	Ref.	Un.	m <sup>3</sup>	7891116
	66960/000	10	0,060	054932
	66960/840*	10	0,060	095614

Contents / Contenido:  
6 Table Spoons / Cucharas de Mesa  
6 Table Forks / Tenedores de Mesa  
6 Table Knives / Cuchillos de Mesa  
6 Tea Spoons / Cucharas para Té



# SKIN PACK | BLISTER SKIN

HAVAÍ		HAVANA MARESIAS		ANGRA LAGUNA		Un.	m <sup>3</sup>	Information/Información	Illustration/Ilustración
Ref.	7891116	Ref.	7891116	Ref.	7891116				
66905/011	169612	66945/011	139103	66903/011	124031	120	0,099	3 pc. Table Spoons   Cucharas de Mesa 3 pzas.	
		66902/011	045978	66906/011	012284				
66905/021	169629	66945/021	139110	66903/021	124048	120	0,099	3 pc. Table Forks   Tenedores de Mesa 3 pzas.	
		66902/021	045985	66906/021	012291				
66905/031	169636	66945/031	139127	66903/031	124055	120	0,037	3 pc. Table Knives   Cuchillos de Mesa 3 pzas.	
		66902/031	045992	66906/031	012307				
		66945/041	144572	66903/041	124079	120	0,099	3 pc. Dessert Spoons   Cucharas de Postre 3 pzas.	
		66902/041	046005	66906/041	012352				
		66902/051	046012	66903/051	124086	120	0,061	3 pc. Dessert Forks   Tenedores de Postre 3 pzas.	
				66906/051	012369				
		66902/061	046029	66903/061	124093	120	0,031	3 pc. Dessert Knives   Cuchillos de Postre 3 pzas.	
				66906/061	012376				
66905/071	169643	66945/071	139141	66903/071	124116	120	0,061	6 pc. Tea Spoons   Cucharas para Té 6 pzas.	
		66902/071	046036	66906/071	012321				
66905/081	169650	66945/081	144596	66903/081	124123	120	0,061	6 pc. Coffee Spoons   Cucharas para Café 6 pzas.	
		66902/081	046043	66906/081	012338				
66905/141	169667	66945/141	144602	66903/141	124130	120	0,099	6 pc. Cake Forks   Tenedores para Pastel 6 pzas.	
		66902/141	046074	66906/141	012413				
66905/181	169674	66945/181	139134	66903/181	124062	120	0,037	3 Pc. Steak Knives   Cuchillos de Asado 3 Pzas.	
		66902/181	046081	66906/181	026304				
		66945/121	144589	66903/121	124109	120	0,099	2 pc. Salad Set Juego para Ensalada 2 pzas.	
		66902/121	046067	66906/121	012390				
		66902/201	046098	66903/201	137734	120	0,061	3 Pc. Ice Drink Spoons   Cucharas para Refresco 3 Pzas.	
				66906/201	012420				
66905/301	169681	66902/301	109038	66903/301	124154	120	0,099	3 Pc. Special Tea Spoons   Cucharas Especiales para Té 3 Pzas.	
				66906/301	012345				
		66902/111	046050	66906/111	012406	120	0,099	6 Pc. Sugar Spoons   Cucharas para Azúcar 6 Pzas.	
				66903/241	137741	120	0,061	6 Pc. Butter Spreaders   Espátulas para Mantequilla 6 Pzas.	
				66906/241	085028				
				66906/563	119631	24	0,014	3 Pc. Flatware Set   Juego de Cubiertos 3 Pzas.	



# HANG-TAG PACKAGING | BLISTER

**HAVAI**

**HAVANA  
MARESIAS**

**ANGRA  
LAGUNA**

Ref. 7891116		Ref. 7891116		Ref. 7891116		Un.	m <sup>3</sup>	Information/Información	Illustration/Ilustración
66905/015	167076	66945/015 66902/015	139158 047897	66903/015 66906/015	123812 037577	120	0,031	3 pc. Table Spoons   Cucharas de Mesa 3 pzas.	
66905/025	167083	66945/025 66902/025	139165 047903	66903/025 66906/025	123829 037584	120	0,031	3 pc. Table Forks   Tenedores de Mesa 3 pzas.	
66905/035	167090	66945/035 66902/035	139172 047910	66903/035 66906/035	123836 037591	120	0,037	3 pc. Table Knives   Cuchillos de Mesa 3 pzas.	
		66945/045 66902/045	144510 047927	66903/045 66906/045	123850 041161	120	0,031	3 pc. Dessert Spoons   Cucharas de Postre 3 pzas.	
		66902/055	047934	66903/055 66906/055	123867 038215	120	0,031	3 pc. Dessert Forks   Tenedores de Postre 3 pzas.	
		66902/065	047941	66903/065 66906/065	123874 041178	120	0,031	3 pc. Dessert Knives   Cuchillos de Postre 3 pzas.	
66905/075	167106	66945/075 66902/075	139196 047958	66903/075 66906/075	123898 037607	120	0,023	6 pc. Tea Spoons   Cucharas para Té 6 pzas.	
66905/085	167113	66945/085 66902/085	144527 047965	66903/085 66906/085	123904 037614	120	0,023	6 pc. Coffee Spoons   Cucharas para Café 6 pzas.	
		66902/115	047972	66906/115	108192	120	0,020	6 pc. Sugar Spoons   Cucharas para Azúcar 6 pzas.	
		63945/125	144541	63903/125 63906/125	127940 119419	48	0,014	2 Pc. Salad Set   Juego para Ensalada 2 pzas.	
66905/145	167212	66945/145 66902/145	144534 047989	66903/145 66906/145	123928 037621	120	0,023	6 pc. Cake Forks   Tenedores para Pastel 6 pzas.	
66905/185	167120	66945/185 66902/185	139189 048009	66903/185 66906/185	123843 037645	120	0,037	3 Pc. Steak Knives   Cuchillos de Asado 3 Pzas.	
66905/305	167137	66902/305	109045	66903/305 66906/305	123881 037638	120	0,030	3 Pc. Special Tea Spoons   Cucharas Especiales para Té 3 Pzas.	
		66902/205	047996	66903/205 66906/205	137727 044070	120	0,031	3 Pc. Ice Drink Spoons   Cucharas para Refresco 3 Pzas.	
				66903/245 66906/505	137765 119372	120	0,020	6 Pc. Butter Spreader   Espátula para Mantequilla 6 Pzas.	
		63902/211	045954	63906/211	012260	48	0,014	1 Pc. Sauce Ladle   Cazo de Salsa Pequeño 1 Pza.	
		63902/091	045831	63906/091	012222	48	0,031	1 Pc. Soup Ladle   Cazo de Sopa 1 Pza.	
		63945/101 63902/101	144619 045879	63903/101 63906/101	123959 012239	48	0,015	1 Pc. Serving Spoon   Cuchara para Servir 1 Pza.	
		63945/151 63902/151	144565 045947	63903/151 63906/151	123935 012246	48	0,015	1 pc. Cake Server   Espátula para Pastel 1 Pza.	
				63906/161	120033	24	0,003	1 Pc. Bread Knife   Cuchillo para Pan 1 Pza.	
		63945/191 63902/191	144558 108208	63903/191 63906/191	123942 012253	48	0,022	1 Pc. Ladle   Cazo Mediano 1 Pza.	
		63902/221	045961	63906/221	012277	48	0,031	1 Pc. Skimmer   Espumadera 1 Pza.	
				63906/401	122549	48	0,015	1 Pc. Spatula   Espátula 1 Pza.	
		63945/471	144626	63903/471 63906/471	123966 048603	48	0,015	1 Pc. Carving Fork   Tenedor 1 Pza.	



**CAKE SET  
JUEGO PARA PASTEL  
7 PC./PZAS.**

	Ref.	Un.	m <sup>3</sup>	7891116
Mareasias	66902/606	16	0,036	106532
Angra	66903/606	16	0,036	124161
Laguna	66906/606	16	0,036	106549

8 units per display box / Caja display con 8 unidades  
16 units per master box / Caja master con 16 unidades



**TABLE FORKS  
TENEDORES DE MESA  
12 PC./PZAS.**

	Ref.	Un.	m <sup>3</sup>	7891116
Mareasias	66902/026	16	0,037	106433
Angra	66903/026	16	0,037	124185
Laguna	66906/026	16	0,037	015681

8 units per display box / Caja display con 8 unidades  
16 units per master box / Caja master con 16 unidades



**TABLE SPOONS  
CUCHARAS DE MESA  
12 PC./PZAS.**

	Ref.	Un.	m <sup>3</sup>	7891116
Mareasias	66902/016	16	0,051	106426
Angra	66903/016	16	0,051	124178
Laguna	66906/016	16	0,051	015674

8 units per display box / Caja display con 8 unidades  
16 units per master box / Caja master con 16 unidades



**DESSERT SPOON  
CUCHARA PARA POSTRE  
12 PC./PZAS.**

	Ref.	Un.	m <sup>3</sup>	7891116
Mareasias	66902/046	16	0,051	171554

8 units per display box / Caja display con 8 unidades  
16 units per master box / Caja master con 16 unidades



**TEA SPOONS  
CUCHARAS PARA TÉ  
12 PC./PZAS.**

	Ref.	Un.	m <sup>3</sup>	7891116
Mareasias	66902/076	16	0,028	106457
Angra	66903/076	16	0,028	124208
Laguna	66906/076	16	0,028	106464

8 units per display box / Caja display con 8 unidades  
16 units per master box / Caja master con 16 unidades



**ICE DRINK SPOONS  
CUCHARAS PARA COCKTAIL  
12 PC./PZAS.**

	Ref.	Un.	m <sup>3</sup>	7891116
Mareasias	66902/206	16	0,037	110591
Angra	66903/206	16	0,037	137758
Laguna	66906/206	16	0,037	110683

8 units per display box / Caja display con 8 unidades  
16 units per master box / Caja master con 16 unidades



**TABLE KNIVES / STEAK KNIVES\*  
CUCHILLOS DE MESA  
CUCHILLOS PARA ASADO\*  
12 PC./PZAS.**

	Ref.	Un.	m <sup>3</sup>	7891116
Mareasias	66902/036	16	0,037	106440
	66902/186*	16	0,037	106471
Angra	66903/036	16	0,037	125410
	66903/186*	16	0,037	124192
Laguna	66906/036	16	0,037	015698
	66906/186*	16	0,037	106488

8 units per display box / Caja display con 8 unidades  
16 units per master box / Caja master con 16 unidades



**FLATWARE SET  
JUEGO DE CUBIERTOS  
24 PC./PZAS.**

	Ref.	Un.	m <sup>3</sup>	7891116
Mareasias	66902/976	12	0,038	106495
	66902/846*	12	0,038	106518
Angra	66903/976	12	0,038	124222
	66903/846*	12	0,038	124215
Laguna	66906/976	12	0,038	106501
	66906/846*	12	0,038	106525

Contents / Contenido:  
6 Table Spoons / Cucharas de Mesa  
6 Table Forks / Tenedores de Mesa  
6 Table Knives / Cuchillos de Mesa  
6 Tea Spoons / Cucharas para Té

6 units per display box / Caja display con 6 unidades  
12 units per master box / Caja master con 12 unidades

\* Steak Knife / Cuchillo para Asado





FLATWARE SET  
JUEGO DE CUBIERTOS  
16 PC./PZAS.

	Ref.	Un.	m <sup>3</sup>	7891116
Havana ■	66945/650	10	0,020	139448
	66945/654*	10	0,020	139455
Maresias ■	66902/650	10	0,020	045572
	66902/654*	10	0,020	106662
Angra ■	66903/650	10	0,020	125243
	66903/654*	10	0,020	125250
Laguna ■	66906/650	10	0,020	045589
	66906/655*	10	0,020	106679

Contents / Contenido:  
4 Table Spoons / Cucharas de Mesa  
4 Table Forks / Tenedores de Mesa  
4 Table Knives / Cuchillos de Mesa  
4 Tea Spoons / Cucharas para Té



FLATWARE SET  
JUEGO DE CUBIERTOS  
16 PC./PZAS.

	Ref.	Un.	m <sup>3</sup>	7891116
Havana ■	66945/550	10	0,045	161777
	66945/554*	10	0,045	145937
Maresias ■	66902/550	10	0,045	106631
	66902/554*	10	0,045	106648
Angra ■	66903/550	10	0,045	125267
	66903/554*	10	0,045	125274
Laguna ■	66906/550	10	0,045	052204
	66906/554*	10	0,045	106655

Contents / Contenido:  
4 Table Spoons / Cucharas de Mesa  
4 Table Forks / Tenedores de Mesa  
4 Table Knives / Cuchillos de Mesa  
4 Tea Spoons / Cucharas para Té



FLATWARE SET  
JUEGO DE CUBIERTOS  
24 PC./PZAS.

	Ref.	Un.	m <sup>3</sup>	7891116
Havana ■	66945/010	10	0,020	139462
	66945/014*	10	0,020	139479
Maresias ■	66902/010	10	0,020	045886
	66902/014*	10	0,020	106686
Angra ■	66903/010	10	0,020	125281
	66903/014*	10	0,020	125298
Laguna ■	66906/000	10	0,020	011416
	66906/014*	10	0,020	106693

Contents / Contenido:  
6 Table Spoons / Cucharas de Mesa  
6 Table Forks / Tenedores de Mesa  
6 Table Knives / Cuchillos de Mesa  
6 Tea Spoons / Cucharas para Té

\* Steak Knife / Cuchillo para Asado



FLATWARE SET  
JUEGO DE CUBIERTOS  
24 PC./PZAS.

	Ref.	Un.	m <sup>3</sup>	7891116
Havana ■	66945/005	10	0,045	161784
	66945/003*	10	0,045	141328
Maresias ■	66902/004*	10	0,045	090725
	66902/005	10	0,045	090732
Angra ■	66903/004*	10	0,045	125311
	66903/005	10	0,045	125304
Laguna ■	66906/004*	10	0,045	090749
	66906/005	10	0,045	090756

Contents / Contenido:  
6 Table Spoons / Cucharas de Mesa  
6 Table Forks / Tenedores de Mesa  
6 Table Knives / Cuchillos de Mesa  
6 Tea Spoons / Cucharas para Té



FLATWARE SET  
JUEGO DE CUBIERTOS  
24 PC./PZAS.

	Ref.	Un.	m <sup>3</sup>	7891116
Havana ■	66945/830	10	0,055	139486
	66945/834*	10	0,055	139493
Maresias ■	66902/830	10	0,055	106709
	66902/834*	10	0,055	106716
Angra ■	66903/830	10	0,055	125229
	66903/834*	10	0,055	125236
Laguna ■	66906/830	10	0,055	106723
	66906/834*	10	0,055	106730

Contents / Contenido:  
6 Table Spoons / Cucharas de Mesa  
6 Table Forks / Tenedores de Mesa  
6 Table Knives / Cuchillos de Mesa  
6 Tea Spoons / Cucharas para Té

\* Steak Knife / Cuchillo para Asado









# SERVING SERVIR

---



## SERVING AND DECORATING

# THE ART OF MAKING THINGS BEUTIFULLY

With trays, plates, serving platters and much more, Tramontina pays true homage to the pleasure of serving well.

These products make organizing, presenting and decorating dishes and ingredients easier and with greater convenience for those who always enjoy doing beautifully well. Stainless steel is used in nearly all of these products, which ensures lightness and sophistication for the most varied occasions, with a shine that highlights the décor of every environment.

## SIRVIENDO Y DECORANDO

# SOBRE EL ARTE DE LUCIRSE

Con bandejas, platos y mucho más, Tramontina rinde un verdadero homenaje al placer de servir bien.

Son productos que facilitan la organización, la presentación e incluso la decoración de alimentos e ingredientes, con mucha más practicidad para los que les gusta lucirse siempre. Presente en casi todas las piezas, el acero inoxidable garantiza que sean livianas y sofisticadas en las más diversas ocasiones - con un brillo que realza la personalidad de cada ambiente.





# TRAYS | BANDEJAS

Polyethylene handles.  
Asas de polietileno.



	RECTANGULAR TRAY BANDEJA RECTANGULAR QUADRATA			
	Ref.	Un.	m <sup>3</sup>	7891116
512 x 368mm	61781/510	02	0,023	110690



	RECTANGULAR TRAY BANDEJA RECTANGULAR QUADRATA			
	Ref.	Un.	m <sup>3</sup>	7891116
385 x 171mm	61781/390	06	0,018	100677



	RECTANGULAR TRAY BANDEJA RECTANGULAR QUADRATA			
	Ref.	Un.	m <sup>3</sup>	7891116
240 x 178mm	61781/250	05	0,017	105047

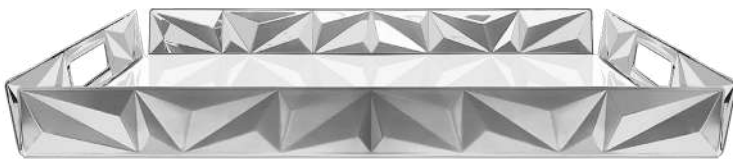

	RECTANGULAR TRAY BANDEJA RECTANGULAR PRISMA			
	Ref.	Un.	m <sup>3</sup>	7891116
518 x 360mm	61560/530	04	0,071	110720



Ergonomic handles.  
Asas ergonómicas.



Folds along the edges of the pieces that increases durability and embellish the item.  
Frisos en los bordes de las piezas que aumentan su resistencia y valorizan la pieza.

RECTANGULAR TRAY  
BANDEJA RECTANGULAR  
CLASSIC

	Ref.	Un.	m <sup>3</sup>	7891116
346 x 242mm	61440/350	05	0,022	000106
420 x 295mm	61440/420	04	0,026	000434
497 x 347mm	61440/490	06	0,053	000380



RECTANGULAR TRAY  
BANDEJA RECTANGULAR  
COSMOS

	Ref.	Un.	m <sup>3</sup>	7891116
385 x 252mm	61316/390	10	0,037	039670



RECTANGULAR TRAY  
BANDEJA RECTANGULAR  
BUENA

	Ref.	Un.	m <sup>3</sup>	7891116
491 x 331mm	61712/480	06	0,053	078693
491 x 331mm	61712/481*	10	0,012	078709
400 x 276mm	61412/400*	30	0,035	000694



RECTANGULAR TRAY  
BANDEJA RECTANGULAR  
CICLO

	Ref.	Un.	m <sup>3</sup>	7891116
422 x 301mm	61529/420	04	0,026	056936





# SERVING PLATTERS

## FUENTES



OVAL FLAT PLATTER  
FUENTE OVALADA LLANA  
SERVICE

	Ref.	Un.	m <sup>3</sup>	7891116
200 x 145mm	61400/200*	70	0,012	006504
250 x 177mm	61400/250*	50	0,012	006559



OVAL DEEP PLATTER  
FUENTE OVALADA HONDA  
SERVICE

	Ref.	Un.	m <sup>3</sup>	7891116
200 x 140mm	61402/200*	70	0,012	006603
263 x 203mm	61402/260*	50	0,012	006610



OVAL DEEP PLATTER  
FUENTE OVALADA HONDA  
BUENA

	Ref.	Un.	m <sup>3</sup>	7891116
203 x 145mm	61702/200*	50	0,013	081402
263 x 202mm	61702/260*	50	0,013	081419
300 x 228mm	61702/300*	50	0,021	082775

\* No packaging / Sin embalaje





**FLAT OVAL PLATTER  
FUENTE OVALADA LLANA  
BUENA**

	Ref.	Un.	m <sup>3</sup>	7891116
250 x 177mm	61700/255	12	0,033	105948

6 Units per display box / Caja display con 6 unidades



**OVAL FLAT PLATTER  
FUENTE OVALADA LLANA  
BUENA**

	Ref.	Un.	m <sup>3</sup>	7891116
201 x 147mm	61700/200*	50	0,013	082751
248 x 177mm	61700/250*	50	0,012	082768
300 x 206mm	61700/300*	50	0,017	081372
405 x 284mm	61700/400*	30	0,033	082959
507 x 366mm	61700/500*	12	0,015	084342



**DEEP OVAL PLATTER  
FUENTE OVALADA HONDA  
BUENA**

	Ref.	Un.	m <sup>3</sup>	7891116
263 x 203mm	61702/265	12	0,033	105955

6 Units per display box / Caja display con 6 unidades

\* No packaging / Sin embalaje







DOUBLE COMPARTMENT DISH WITH  
GLASS LID  
FUENTE DIVIDIDA CON TAPA DE VIDRIO  
CICLO

	Ref.	Un.	m <sup>3</sup>	7891116
450 x 310mm	61525/454	04	0,061	056905

**SERVING DISHES WITH LID KEEPS FOOD WARMER FOR LONGER.**  
**LAS FUENTES CON TAPA MANTIENEN LOS ALIMENTOS CALIENTES POR MÁS TIEMPO.**



COVERED ROUND DISH  
PLATO REDONDO CON TAPA DE VIDRIO  
CICLO

	Ref.	Un.	m <sup>3</sup>	7891116
Ø 30cm	61528/304	05	0,049	056912
Ø 39cm	61528/394	03	0,047	056929



COVERED OVAL DEEP PLATTER  
FUENTE OVALADA HONDA CON TAPA  
CICLO

	Ref.	Un.	m <sup>3</sup>	7891116
450 x 310mm	61517/454	04	0,061	057209
390mm - Lid/ Tapa	62713/394	04	0,024	060018



FISH PLATTER  
FUENTE PARA PESCADO  
BUENA

	Ref.	Un.	m <sup>3</sup>	7891116
501 x 236mm	61703/501*	08	0,014	084953
603 x 279mm	61703/601*	08	0,014	085554

# SALAD BOWLS ENSALADERAS



SALAD SET  
JUEGO PARA ENSALADA  
3 PC./PZAS.  
LAPIDAR

Ref.	Un.	m <sup>3</sup>	7891116
64550/210	02	0,037	114247

Contents / Contenido:  
1 Salad Bowl / Ensaladera Ø 29,8cm - 4,50l  
1 Salad Fork / Tenedor para Ensalada  
1 Salad Spoon / Cuchara para Ensalada



## PLATE | PLATO



ROUND FLAT DISH  
PLATO REDONDO LLANO  
SERVICE

	Ref.	Un.	m <sup>3</sup>	7891116
Ø 23cm	61416/231*	12	0,006	069035

## FLOUR BOWL POTE PARA HARINA



FLOUR BOWL  
POTE PARA HARINA  
SERVICE

	Ref.	Un.	m <sup>3</sup>	7891116
1,13l	64400/510	06	0,030	002285
0,70l	64400/520	06	0,020	051993
0,70l	64400/521*	06	0,017	051931

## SAUCE BOAT | SALSERA



SAUCE BOAT SET  
JUEGO PARA SALSA  
2 PC./PZAS.  
SERVICE

	Ref.	Un.	m <sup>3</sup>	7891116
0,19l	64400/300	12	0,030	000502

Contents / Contenido:  
1 Sauce Boat / Salsera  
1 Sauce Ladle / Cazo de Salsa Pequeño



# BUTTER DISHES

## MANTEQUILLERAS



COVERED BUTTER DISH MANTEQUILLERA CON TAPA QUADRATA				
	Ref.	Un.	m <sup>3</sup>	7891116
0,05l	61787/000	08	0,017	105085



COVERED BUTTER DISH MANTEQUILLERA CON TAPA CICLO				
	Ref.	Un.	m <sup>3</sup>	7891116
0,20l	61519/000	12	0,027	057018



COVERED BUTTER BOWL MANTEQUILLERA CON TAPA UTILITY				
	Ref.	Un.	m <sup>3</sup>	7891116
0,18l	61473/080	12	0,013	001424



COVERED BUTTER DISH MANTEQUILLERA CON TAPA ROTONDA				
	Ref.	Un.	m <sup>3</sup>	7891116
0,21l	61273/000	12	0,024	006368



COVERED BUTTER DISH MANTEQUILLERA CON TAPA SERVICE				
	Ref.	Un.	m <sup>3</sup>	7891116
	61424/000	12	0,027	000243

# SOUP TUREEN SOPERA



COVERED SOUP TUREEN  
SOPERA CON TAPA  
SERVICE

	Ref.	Un.	m <sup>3</sup>	7891116
Ø 24cm - 2,75l	61410/240	06	0,071	000847
Ø 24cm - 2,75l	61410/241*	06	0,045	017647

# SWEET AND COLD CUTS DULCES Y FIAMBRES



TRAY FOR COLD CUTS  
BANDEJA PARA FIAMBRES  
CICLO

	Ref.	Un.	m <sup>3</sup>	7891116
323 x 184mm	64510/610	06	0,023	061169

Polystyrene cover  
Tapa de poliestireno



TRAY FOR COLD CUTS  
BANDEJA PARA FIAMBRES  
QUADRATA

	Ref.	Un.	m <sup>3</sup>	7891116
286 x 196mm	64780/610	05	0,030	100684



PLATE WITH COVER  
PLATO CON TAPA  
QUADRATA

	Ref.	Un.	m <sup>3</sup>	7891116
385 x 171mm	64780/680	04	0,056	100691



CAKE SET  
JUEGO PARA PASTEL  
CICLO

	Ref.	Un.	m <sup>3</sup>	7891116
Ø 39,5cm	64510/190	02	0,059	062517

Polystyrene cover  
Tapa de poliestireno



CAKE SET  
JUEGO PARA PASTEL  
CICLO

	Ref.	Un.	m <sup>3</sup>	7891116
Ø 39,5cm	64510/090	02	0,059	060285
Ø 33,3cm	64510/080	04	0,079	060278



CHEESE/CAKE CONTAINER SET  
JUEGO PARA QUESO/PASTEL  
CICLO

	Ref.	Un.	m <sup>3</sup>	7891116
Ø 25cm	64510/670	04	0,046	081334





CHEESE CONTAINER SET  
JUEGO PARA QUESO  
CICLO

	Ref.	Un.	m <sup>3</sup>	7891116
Ø 20cm	64510/620	04	0,025	070123

## FRUIT BOWL FRUTERO



FRUIT BOWL  
FRUTERO CON BASE  
COSMOS

	Ref.	Un.	m <sup>3</sup>	7891116
Ø 32cm	61114/320	08	0,070	021422

## DESSERT SETS JUEGOS PARA POSTRE



DESSERT DISH  
TAZA PARA POSTRE  
SERVICE

	Ref.	Un.	m <sup>3</sup>	7891116
0,16l	61339/112*	24	0,005	064542
0,12l	61339/113*	24	0,005	079362



DESSERT DISH  
TAZA PARA POSTRE  
SERVICE

	Ref.	Un.	m <sup>3</sup>	7891116
Ø 9,7cm - 0,15l	61421/090*	60	0,027	006535

\* No packaging / Sin embalaje

# *Serving Sets*

# *Juegos para*

# *Servir*



Complete or compact solutions for all family sizes. With Tramontina's serving sets, you will always have excellent options to serve. In addition to being practical, hygienic, and easy to clean, they make any table much more charming and complete.

**STAINLESS STEEL**  
**VERSATILITY**

Soluciones completas o compactas, para todo tipo de familia. Con los juegos de vajilla Tramontina usted siempre tiene excelentes opciones en el momento de servir. Además de prácticas, higiénicas y fáciles de limpiar, hacen que cualquier mesa quede mucho más encantadora y completa.

**ACERO INOXIDABLE**  
**VERSATILIDAD**



**SERVING SET**  
**JUEGO PARA SERVIR**  
 3 PC./PZAS.  
 CICLO

Ref.	Un.	m <sup>3</sup>	7891116
64510/184	03	0,055	070475

**Contents / Contenido:**  
 1 Oval Deep Platter with Glass Lid / Fuente Ovalada Honda con Tapa de Vidrio Templada 401 x 275mm  
 1 Spaghetti tong / Pinza para Pasta  
 1 Serving Spoon / Cuchara para Servir



**SERVING SET**  
**JUEGO PARA SERVIR**  
 3 PC./PZAS.  
 CICLO

Ref.	Un.	m <sup>3</sup>	7891116
64510/264	04	0,045	083116

**Contents / Contenido:**  
 1 Deep Dish with Tempered Glass Lid / Plato Hondo con Tapa de Vidrio Templada Ø 30cm  
 1 Spaghetti Tong / 1 Pinza para Pasta  
 1 Serving Spoon / Cuchara para Servir



**SERVING SET**  
**JUEGO PARA SERVIR**  
 3 PC./PZAS.  
 CICLO

Ref.	Un.	m <sup>3</sup>	7891116
64510/274	04	0,083	083697

**Contents / Contenido:**  
 1 Round Deep Platter with Glass Lid / Plato Redondo Hondo con Tapa de Vidrio Ø 39cm  
 1 Spaghetti Tong / Pinza para Pasta  
 1 Salad Spoon / Cuchara para Ensalada







**SERVING SET**  
**JUEGO PARA SERVIR**  
 6 PC./PZAS.  
 CICLO

Ref.	Un.	m <sup>3</sup>	7891116
64510/860	04	0,085	067284

Contents / Contenido:  
 1 Oval Flat Platter / Fuente Ovalada Llana 252 x 175mm  
 1 Oval Deep Platter / Fuente Ovalada Honda 252 x 175mm  
 1 Oval Deep Platter / Fuente Ovalada Honda 302 x 209mm  
 1 Spaghetti Tong / Pinza para Pasta  
 1 Salad Spoon / Cuchara para Ensalada  
 1 Salad Fork / Tenedor para Ensalada

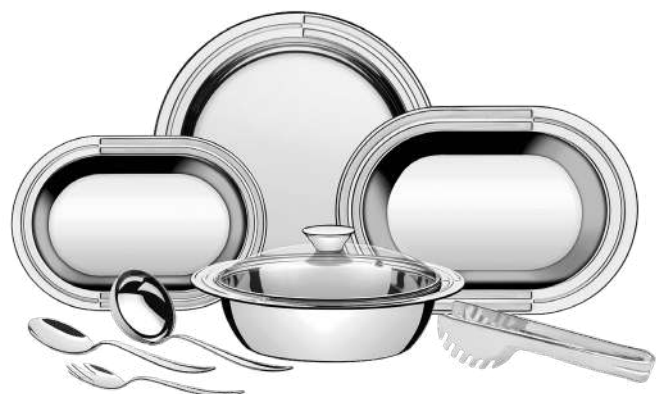

**SERVING SET**  
**JUEGO PARA SERVIR**  
 8 PC./PZAS.  
 CICLO

Ref.	Un.	m <sup>3</sup>	7891116
64510/890	03	0,137	070369

Contents / Contenido:  
 1 Round Flat Dish / Plato Redondo Ø 30cm  
 1 Oval Flat Platter / Fuente Ovalada Llana 302 x 209mm  
 1 Oval Deep Platter / Fuente Ovalada Honda 252 x 175mm  
 1 Container with Glass Lid / Recipiente con Tapa de Vidrio Ø 26cm - 1,90l  
 1 Salad Spoon / Cuchara para Ensalada  
 1 Salad Fork / Tenedor para Ensalada  
 1 Spaghetti Tong / Pinza para Pasta  
 1 Ladle / Cazo Mediano



**CAKE SET**  
**JUEGO PARA PASTEL**  
 9 PC./PZAS.  
 CICLO

Ref.	Un.	m <sup>3</sup>	7891116
64510/880	04	0,079	067307

Contents / Contenido:  
 1 Round Flat Dish / Plato Redondo Ø 33,3cm  
 1 Polystyrene Cover / Tapa de Poliestireno  
 1 Cake Server / Espátula para Pastel  
 6 Cake Forks / Tenedores para Pastel



# THERMAL BEVERAGE DISPENSERS

## TERMOS

---



Exclusive material for legal entities/corporate clients.  
Material exclusivo para clientes persona jurídica.



**AT THE PERFECT TEMPERATURE**

# **YOUR FAVORITE DRINKS ALWAYS READY TO DRINK**

Tramontina's thermal tea and coffee pots and beverage dispensers are the ideal companions for those who enjoy a nice cold juice, a good coffee kept warm for longer, and other beverages always at the right temperature.

The stainless steel finish ensures durability and lightness for carrying. The design makes them easy to use, and they look beautiful anywhere for any occasion. An indispensable choice.

**EN LA TEMPERATURA IDEAL**

# **TUS BEBIDAS FAVORITAS SIEMPRE LISTAS PARA BEBER**

Las jarras térmicas y termos de Tramontina son la compañía ideal para los que aprecian un jugo bien helado, un café calentito durante más tiempo y otras bebidas siempre a la temperatura ideal.

El revestimiento en acero inoxidable garantiza que sean durables y livianos para el transporte. Ya el diseño facilita el uso y se luce en cualquier lugar y ocasión. Una elección indispensable.





## **DISTINGUISHING FEATURES OF TRAMONTINA THERMAL TEA AND COFFEE POTS AND BEVERAGE DISPENSERS:**

### **DIFERENCIALES DE LOS TERMOS Y JARRAS TÉRMICAS TRAMONTINA:**

#### **CONFORT | COMODIDAD**

The handles ensure a firm grip and provide greater safety when carrying and serving.

Los mangos y asas garantizan firmeza en el manejo y proporcionan más seguridad en el transporte y en el momento de servir.

#### **SAFETY LATCH**

#### **TRABA DE SEGURIDAD**

The pump-operated beverage dispensers have a device that prevents accidental spills.

Los termos con bomba cuentan con un mecanismo que evita el accionamiento involuntario.

#### **CONTEMPORARY DESIGN DISEÑO MODERNO**

With timeless lines, the Exata beverage dispensers and tea and coffee pots are extremely functional, with elegance and sophistication.

Con líneas atemporales, los termos y jarras térmicas Exata garantizan funcionalidad plena con toda la elegancia y sofisticación.

#### **DRIP-STOP SYSTEM | ANTIGOTEO**

The whole line has a mechanism that prevents dripping after serving.

Toda la línea cuenta con un mecanismo que evita el goteo indeseable después de servir.





# THERMAL CARAFE

## JARRA TÉRMICA





PANTONE 2022



THERMAL CARAFE  
JARRA TÉRMICA  
1L

	Ref.	Un.	m <sup>2</sup>	7891116
■	61636/103	06	0,030	169544
■	61636/106	06	0,030	169551
■	61636/107	06	0,030	169568
■	61636/108	06	0,030	169575
■	61636/101	06	0,030	175231
■	61636/104	06	0,030	175248

NEW RELEASE  
LANZAMIENTO



# VACUUM INSULATED BOTTLE TERMO



## SCREW LID / TAPA DE ROSCA

Ideal for measuring  
the volume of liquid.  
Ideal para medir el  
volumen de líquido.



## ERGONOMIC NOZZLE / PICO ERGONÓMICA DUO 360°

Easy handling and precision  
when serving.  
Fácil manejo y precisión  
al servir.

## LID/CUP TRANSPARENT TAPA/VASO TRANSPARENTE

Convenience to serve  
different types of drinks.  
Conveniencia para servir  
diferentes tipos de bebidas.



## THREADED CAP / CORCHO

It allows to serve in 360°, in a  
conventional way (unscrewed)  
or through the spout.  
Permite servir en 360°,  
de forma convencional  
(desenroscado) o mediante  
el pitorro.

## ISULATED GLASS AMPOULE AMPOLLA DE VIDRIO

Vacuum insulated glass.  
Ampolla de vidrio.

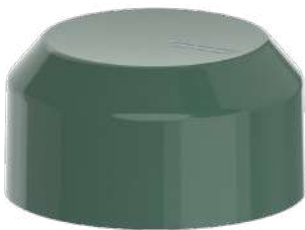

## LID/CUP TAPA/VASO

In the color of the bottle.  
En el color de lo termo.

## HANDLE | ASA

Extra safe and comfortable  
handle with smooth grip.  
Asa cómoda con toque  
suave y muy segura.

## PERFECT SEAL CIERRE PERFECTO

Millimeter regulator keeps perfect  
seal for many years.  
Regulador milimétrico que mantiene  
el cierre perfecto a lo largo de los años.





Exclusive material for legal entities/corporate clients.  
Material exclusivo para clientes persona jurídica.



VACUUM INSULATED BOTTLE  
TERMO  
1L

	Ref.	Un.	m <sup>3</sup>	7891116
■	61637/103	06	0,026	169506
■	61637/106	06	0,026	169513
■	61637/107	06	0,026	169520
■	61637/108	06	0,026	169537



NEW RELEASE  
LANZAMIENTO

VACUUM INSULATED BOTTLE  
TERMO  
1L

	Ref.	Un.	m <sup>3</sup>	7891116
■	61637/503	06	0,026	175224
■	61637/506	06	0,026	175255
■	61637/507	06	0,026	175262



GLASS AMPOULE  
AMPOLLA DE VIDRIO  
1L

	Ref.	Un.	m <sup>3</sup>	7891116
	61636/930	04	0,033	171103



VACUUM INSULATED BOTTLE  
TERMO

	Ref.	Un.	m <sup>3</sup>	7891116
0,75l	61640/370	06	0,018	149355
1,00l	61640/400	06	0,023	149362



VACUUM INSULATED BEVERAGE DISPENSER  
TERMO CON SIFÓN

	Ref.	Un.	m <sup>3</sup>	7891116
1,40l	61642/140	04	0,025	123553
2,00l	61642/200	04	0,032	123560



VACUUM INSULATED BEVERAGE DISPENSER  
TERMO CON SIFÓN

	Ref.	Un.	m <sup>3</sup>	7891116
1,20l	61641/120	04	0,025	123539
1,80l	61641/180	04	0,032	123546



NEW RELEASE  
LANZAMIENTO

VACUUM INSULATED BEVERAGE DISPENSER  
TERMO CON SIFÓN

	Ref.	Un.	m <sup>3</sup>	7891116
1,20l	61641/123	04	0,025	174630



VACUUM INSULATED GLASS AMPOULE  
AMPOLLA DE VIDRIO PARA  
TERMO CON SIFÓN

	Ref.	Un.	m <sup>3</sup>	7891116
1,20l	61641/900	04	0,027	127339
1,80l	61641/910	04	0,033	127346





THERMAL CARAFE  
JARRA TÉRMICA  
0,30L - WITHOUT INFUSER / SIN INFUSOR

	Ref.	Un.	m <sup>3</sup>	7891116
■	61645/030	06	0,019	123577
■	61645/033	06	0,019	169148
□	61645/034	06	0,019	123584
■	61645/036	06	0,019	123591

0,30L - WITH INFUSER / CON INFUSOR

	Ref.	Un.	m <sup>3</sup>	7891116
■	61644/030	06	0,019	125953
□	61644/034	06	0,019	125960
■	61644/036	06	0,019	125977



THERMAL CARAFE  
JARRA TÉRMICA  
0,50L - WITHOUT INFUSER / SIN INFUSOR

	Ref.	Un.	m <sup>3</sup>	7891116
■	61645/050	06	0,023	123607
■	61645/053	06	0,023	169155
□	61645/054	06	0,023	123614
■	61645/056	06	0,023	123621

0,50L - WITH INFUSER / CON INFUSOR

	Ref.	Un.	m <sup>3</sup>	7891116
■	61644/050	06	0,023	125984
□	61644/054	06	0,023	125991
■	61644/056	06	0,023	126004



THERMAL CARAFE  
JARRA TÉRMICA  
0,75L - WITHOUT INFUSER / SIN INFUSOR

	Ref.	Un.	m <sup>3</sup>	7891116
■	61645/070	06	0,030	123638
■	61645/073	06	0,030	169162
□	61645/074	06	0,030	123645
■	61645/076	06	0,030	123652

0,75L - WITH INFUSER / CON INFUSOR

	Ref.	Un.	m <sup>3</sup>	7891116
■	61644/070	06	0,030	126011
□	61644/074	06	0,030	126028
■	61644/076	06	0,030	126035



**THERMAL CARAFE  
JARRA TÉRMICA  
1,00L - WITHOUT INFUSER / SIN INFUSOR**

	Ref.	Un.	m <sup>3</sup>	7891116
■	61645/100	06	0,033	123669
■	61645/103	06	0,033	169179
□	61645/104	06	0,033	123676
■	61645/106	06	0,033	123683

**1,00L - WITH INFUSER / CON INFUSOR**

	Ref.	Un.	m <sup>3</sup>	7891116
■	61644/100	06	0,033	126042
□	61644/104	06	0,033	126059
■	61644/106	06	0,033	126066



**VACUUM INSULATED  
GLASS AMPOULE  
AMPOLLA DE VIDRIO PARA  
JARRA TÉRMICA**

	Ref.	Un.	m <sup>3</sup>	7891116
0,30l	61645/900	04	0,017	127353
0,50l	61645/910	04	0,017	127360
0,75l	61645/920	04	0,027	127377
1,00l	61645/930	04	0,033	127384

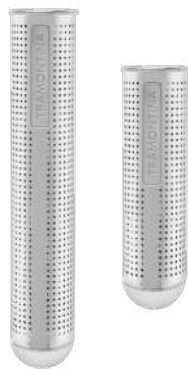

**INFUSER  
INFUSOR**

	Ref.	Un.	m <sup>3</sup>	7891116
Compatible - 1l / 0,75l	61644/900	06	0,004	126516
Compatible - 0,50l / 0,30l	61644/901	10	0,002	139387



**VACUUM ISULATED STAINLESS  
STEEL CARAFE  
JARRA TÉRMICA DE ACERO INOXIDABLE**

	Ref.	Un.	m <sup>3</sup>	7891116
750 ml	61638/070	06	0,020	158685
1,00 ml	61638/100	06	0,032	158692



Exclusive material for legal entities/corporate clients.  
Material exclusivo para clientes persona jurídica.





TRITAN WATER BOTTLE  
 BOTELLA PARA AGUA TRITAN  
 0,60L

	Ref.	Un.	m <sup>3</sup>	7891116
■	61643/063*	04	0,009	136683
■	61643/065*	04	0,009	137468



TRITAN WATER BOTTLE  
 BOTELLA PARA AGUA TRITAN  
 0,90L

	Ref.	Un.	m <sup>3</sup>	7891116
■	61646/086*	04	0,009	136195

\* Imported Product / Producto Importado

# TEA AND COFFEE

## TÉ Y CAFÉ

---





**PREPARE AND ENJOY**

# STARTING THE DAY OR JUST RELAXING

Tramontina's kettles, tea and coffee pots and other accessories highlight the aromas and sensations of those moments when all that life demands is a good cup of tea or coffee.

These products stand out due to their contemporary design and resistance, with quality that performs beautifully on every occasion, from a simple breakfast to a genuine afternoon tea.

**PREPARAR Y SABOREAR**

# PARA COMENZAR EL DÍA O RELAJAR

Las teteras, cafeteras y demás accesorios Tramontina destacan los aromas y sensaciones de aquellos momentos en que todo lo que la vida pide es una taza de té o un buen café.

Los productos se diferencian por el diseño moderno y la resistencia, con una calidad que se luce en todas las ocasiones - desde un prosaico desayuno hasta un genuino té de las cinco.





NEW RELEASE  
LANZAMIENTO

FRENCH PRESS  
PRENSA FRANCESA DE CAFÉ

	Ref.	Un.	m <sup>3</sup>	7891116
0,60l	61767/560*	04	-	170823



NEW RELEASE  
LANZAMIENTO

FRENCH PRESS  
PRENSA FRANCESA DE CAFÉ

	Ref.	Un.	m <sup>3</sup>	7891116
1,00l	61767/600*	04	-	170830



NEW RELEASE  
LANZAMIENTO

COFFEE POT  
CAFETERA

	Ref.	Un.	m <sup>3</sup>	7891116
0,32l	61768/010*	04	-	171288



Gas  
Gas



Electric  
Eléctrica



Ceramic Glass  
Vitrocerámico



NEW RELEASE  
LANZAMIENTO

COFFEE POT  
CAFETERA

	Ref.	Un.	m <sup>3</sup>	7891116
0,32l	61768/020*	04	-	171295



Gas  
Gas



Electric  
Eléctrica



Ceramic Glass  
Vitrocerámico



ITALIAN ESPRESSO COFFEE MAKER  
CAFETERA ESPRESSO ITALIANA

	Ref.	Un.	m <sup>3</sup>	7891116
0,35l	61768/100*	04	0,020	170755



Gas  
Gas



Electric  
Eléctrica



Ceramic Glass  
Vitrocerámico



Induction  
Inducción



NEW RELEASE  
LANZAMIENTO

COFFEE MAKER WITH STRAINER  
CAFETERA CON COLADOR

	Ref.	Un.	m <sup>3</sup>	7891116
0,40l	61764/060*	04	-	170816



NEW RELEASE  
LANZAMIENTO

COFFEE STRAINER  
COLADOR DE CAFÉ

	Ref.	Un.	m <sup>3</sup>	7891116
	61760/000*	04	-	171264







NEW RELEASE  
LANZAMIENTO

GOOSENECK KETTLE  
HERVIDOR DE CUELLO DE CISNE

	Ref.	Un.	m <sup>3</sup>	7891116
1,20l	61768/510*	04	-	173862



Ideal for preparing  
brewed beverages.  
Ideal para preparar  
bebidas elaboradas.



NEW RELEASE  
LANZAMIENTO

GOOSENECK TEA/COFFEE POT  
TETERA CUELLO DE CISNE

	Ref.	Un.	m <sup>3</sup>	7891116
0,60l	61768/500*	04	-	171301



NEW RELEASE  
LANZAMIENTO

COFFEE GRINDER  
MOLINILLO DE CAFÉ

	Ref.	Un.	m <sup>3</sup>	7891116
	61769/010*	04	-	171271



COFFEE GRINDER  
MOLINILLO DE CAFÉ

	Ref.	Un.	m <sup>3</sup>	7891116
	61769/000*	04	0,012	157879









NEW RELEASE  
LANZAMIENTO

DOSING SCALE  
EQUILIBRIO DE DOSIFICACIÓN

WEIGHS UP TO 25 G  
PESA HASTA 25 G

Ref.	Un.	m <sup>3</sup>	7891116
61101/100	04	-	170809



NEW RELEASE  
LANZAMIENTO

COFFEE TASTING SPOON  
CUCHARA DE DEGUSTACIÓN

Ref.	Un.	m <sup>3</sup>	7891116
63986/230	12	0,002	172346

THE GLASS TEAPOTS ON THIS PAGE CAN GO STRAIGHT TO THE STOVE.

LAS TETERAS DE VIDRIO DE ESTA PÁGINA PUEDEN IR DIRECTAMENTE A LA ESTUFA.



Gas  
Gas



Electric  
Eléctrica



Ceramic Glass  
Vidrocerámico



TEAPOT  
TETERA

	Ref.	Un.	m <sup>3</sup>	7891116
1,00l	61764/100*	04	0,040	159330



TEAPOT  
TETERA

	Ref.	Un.	m <sup>3</sup>	7891116
0,60l	61763/060*	04	0,020	158906



TEAPOT  
TETERA

	Ref.	Un.	m <sup>3</sup>	7891116
0,90l	61762/090*	04	0,030	159347







# STAINLESS STEEL CUPS

## TAZAS DE ACERO



COFFEE CUP SET  
JUEGO DE TAZAS DE CAFÉ  
2 PC./PZAS.

	Ref.	Un.	m <sup>3</sup>	7891116
0,07l	64760/600	04	0,004	160077



COFFEE CUP SET  
JUEGO DE TAZAS DE CAFÉ  
2 PC./PZAS.

	Ref.	Un.	m <sup>3</sup>	7891116
0,09l	64760/500	04	0,007	160084



COFFEE CUP SET  
JUEGO DE TAZAS DE CAFÉ  
2 PC./PZAS.

	Ref.	Un.	m <sup>3</sup>	7891116
0,08l	64430/780	04	0,007	089170

CAPPUCCINO AND TEA CUP SET  
JUEGO DE TAZAS PARA  
TÉ Y CAPPUCCINO  
2 PC./PZAS.

	Ref.	Un.	m <sup>3</sup>	7891116
0,23l	64430/790	05	0,017	089187



COFFEE SET  
JUEGO PARA CAFÉ

	Ref.	Un.	m <sup>3</sup>	7891116
6 Pc./Pzas.	64430/800	04	0,020	005743

Contents / Contenido:  
2 Saucers / Platos 11,5cm  
2 Cups / Tazas 0,08l  
2 Coffee Spoons / Cucharas para Café

18 Pc./Pzas.	64430/810	05	0,059	000335
--------------	-----------	----	-------	--------

Contents / Contenido:  
6 Saucers / Platos 11,5cm  
6 Cups / Tazas 0,08l  
6 Coffee Spoons / Cucharas para Café





TEA & CAPPUCCINO SET  
 JUEGO PARA TÉ & CAPPUCCINO  
 18 PC./PZAS.

Ref.	Un.	m <sup>3</sup>	7891116
64430/820	05	0,101	000281

Contents / Contenido:  
 6 Saucers / Platos  
 6 Cups / Tazas - 0,23l  
 6 Coffee Spoons / Cucharas para Café





# GLASS CUPS TAZAS DE VIDRO



With double walls, the pieces are extremely safe and contemporary.  
Con paredes dobles, las piezas son seguras y extremadamente modernas.

COFFEE CUP SET  
JUEGO DE TAZAS PARA CAFÉ  
2 PC./PZAS.

	Ref.	Un.	m <sup>3</sup>	7891116
0,11l	64760/400*	04	0,012	089217



CAPPUCCINO AND TEA CUP SET  
JUEGO DE TAZAS PARA  
TÉ Y CAPPUCCINO  
2 PC./PZAS.

	Ref.	Un.	m <sup>3</sup>	7891116
0,27l	64760/410*	02	0,012	089224



TEA & CAPPUCCINO SET  
JUEGO PARA TÉ Y CAPPUCCINO  
2 PC./PZAS.

	Ref.	Un.	m <sup>3</sup>	7891116
0,27l	64760/420*	04	0,021	160053

# TEA AND COFFEE POTS

## CAFETERA Y LECHERA



COVERED COFFEE & MILK POT CAFETERA Y LECHERA HARMONY				
	Ref.	Un.	m <sup>3</sup>	7891116
0,35l	61581/090	03	0,005	098707



COVERED COFFEE & MILK POT CAFETERA Y LECHERA HARMONY				
	Ref.	Un.	m <sup>3</sup>	7891116
0,44l	61580/090	04	0,010	098691



COFFEE & MILK POT CAFETERA Y LECHERA BUENA				
	Ref.	Un.	m <sup>3</sup>	7891116
Ø 8cm - 0,55l	61570/080	04	0,012	121009
Ø 10cm - 0,90l	61570/100	04	0,015	121016



PITCHER WITH HINGED LID JARRA CON TAPA BUENA				
	Ref.	Un.	m <sup>3</sup>	7891116
Ø 12cm - 2,10l	61575/120	04	0,020	120026
Ø 14cm - 2,90l	61575/140	04	0,033	121023



COVERED COFFEE & MILK POT CAFETERA Y LECHERA LADY				
	Ref.	Un.	m <sup>3</sup>	7891116
Ø 7,1cm - 0,26l	61470/070	12	0,012	006085
Ø 8,4cm - 0,47l	61470/080	10	0,017	004104
Ø 10cm - 0,78l	61470/100	10	0,027	004609
Ø 11,5cm - 1,27l	61470/110	08	0,031	002001



PITCHER WITH LID  
JARRA CON TAPA  
LADY

	Ref.	Un.	m <sup>3</sup>	7891116
Ø 12,6cm - 2,00l	61475/120	04	0,020	001585
Ø 14,1cm - 2,80l	61475/140	04	0,030	003299



NEW RELEASE  
LANZAMIENTO

BARISTA MILK POT  
LECHERA PARA BARISTA  
CONTINENTAL

	Ref.	Un.	m <sup>3</sup>	7891116
Ø 8cm - 0,44l	61437/080	04	0,007	067901
Ø 8cm - 0,44l	61437/081*	04	0,006	067918

Ideal for vaporizing milk, and with the channel of the spout more elongated, it meets the expectations of the more demanding barista.

Ideal para la vaporización de la leche, su pico con canal más alargado cumple con las expectativas de los baristas más exigentes.



\* No packaging / Sin embalaje





**SACHET HOLDER  
PORTA SACHET**

	Ref.	Un.	m <sup>3</sup>	7891116
	61531/000	10	0,007	075210



**RECTANGULAR TRAY  
BANDEJA RECTANGULAR**

	Ref.	Un.	m <sup>3</sup>	7891116
	61760/476	04	0,043	089385



**BUTTER SPREADER SET  
JUEGO DE ESPÁTULAS  
PARA MANTEQUILLA  
4 PC./PZAS.**

	Ref.	Un.	m <sup>3</sup>	7891116
Laguna	66906/730	20	0,012	083840
Cosmos	66950/730	20	0,012	080948



**COFFEE SPOONS SET  
JUEGO DE CUCHARAS PARA CAFÉ  
6 PC./PZAS.**

	Ref.	Un.	m <sup>3</sup>	7891116
	66999/510	15	0,005	100646

# SUGAR BOWLS AZUCAREROS



SUGAR BOWL WITH SPOON  
AZUCARERO CON CUCHARA  
SERVICE

	Ref.	Un.	m <sup>3</sup>	7891116
Ø 9,1cm - 0,32l	64400/500	10	0,012	000625



SUGAR BOWL WITH SPOON  
AZUCARERO CON CUCHARA  
LADY

	Ref.	Un.	m <sup>3</sup>	7891116
Ø 8,4cm - 0,35l	64470/500	12	0,015	000854
Ø 10cm - 0,60l	64470/510	08	0,017	004753



SUGAR BOWL WITH SPOON  
AZUCARERO CON CUCHARA  
HARMONY

	Ref.	Un.	m <sup>3</sup>	7891116
0,20l	64580/500	06	0,013	098721



SUGAR BOWL WITH SPOON  
AZUCARERO CON CUCHARA  
QUADRATA

	Ref.	Un.	m <sup>3</sup>	7891116
Ø 9,3cm - 0,35l	64780/500	06	0,007	100707



SUGAR BOWL WITH SPOON  
AZUCARERO CON CUCHARA  
BUENA

	Ref.	Un.	m <sup>3</sup>	7891116
Ø 8cm - 0,40l	64570/500	04	0,006	122594

# TEA AND COFFEE SET

## KIT DE TÉ Y CAFÉ



TEA & COFFEE SET  
 JUEGO PARA TÉ & CAFÉ  
 5 PC./PZAS.  
 HARMONY

Ref.	Un.	m <sup>3</sup>	7891116
64580/890	03	0,042	100653

Contents / Contenido:  
 1 Rectangular Tray / Bandeja Rectangular  
 385x171mm  
 1 Sugar Bowl / Azúcarero - 0,20l  
 1 Sugar Spoon / Cuchara para Azúcar  
 1 Coffee & Milk Pot / Cafetera y Lechera 0,44l  
 1 Coffee & Milk Pot / Cafetera y Lechera 0,35l





# TEA KETTLES TETERAS



WHISTLING TEA KETTLE  
TETERA CON SILBATO

	Ref.	Un.	m <sup>3</sup>	7891116
2,10l	61483/013	04	0,042	147955



WHISTLING TEA KETTLE  
TETERA CON SILBATO

	Ref.	Un.	m <sup>3</sup>	7891116
3,00l	61483/023	04	0,053	155615



TEA KETTLE  
TETERA

	Ref.	Un.	m <sup>3</sup>	7891116
1,50l	61485/160	06	0,053	137147



TEA KETTLE TETERA				
	Ref.	Un.	m <sup>3</sup>	7891116
1,30l	61482/150	04	0,030	001875



TEA KETTLE TETERA				
	Ref.	Un.	m <sup>3</sup>	7891116
2,25l	61482/183	04	0,042	147948



TEA KETTLE TETERA				
	Ref.	Un.	m <sup>3</sup>	7891116
Ø 21cm - 3,35l	61488/213*	04	0,087	170977





# BAR

---



Exclusive material for legal entities/corporate clients.  
Material exclusivo para clientes persona jurídica.

## SERVING IN STYLE

# CELEBRATE EVERY DAY

Time to celebrate! With measures, cocktail shakers, ice buckets and much more, Tramontina's Bar line takes over the dance floor with the glamour of stainless steel.

Convenient and resistant, these products guarantee to liven up all types of get-togethers and do beautifully well in any environment, whether at home or in bars, restaurants or other commercial establishments. The right choice for those who enjoy delighting friends, guests or customers.

## SIRVIENDO CON ESTILO

# TODOS LOS DÍAS SON DÍAS PARA CELEBRAR

¡Es hora de celebrar! Con dosificadores, cocteleras, baldes de hielo y mucho más, la línea Bar de Tramontina invade la pista embalada por el glamour del acero inoxidable.

Prácticos y resistentes, los productos garantizan la animación de los más diversos tipos de confraternizaciones y se lucen en cualquier ambiente - tanto en casa como en bares, restaurantes y otros establecimientos comerciales. La elección adecuada para quienes tienen el placer de encantar a los amigos, invitados o clientes.



# ACCESSORIES ACCESORIOS



NEW RELEASE  
LANZAMIENTO

DOUBLE-SIDED JIGGER  
DOSIFICADOR DE BEBIDAS DOBLE

	Ref.	Un.	m <sup>3</sup>	7891116
25/50 ml	61347/000*	12	-	172940



WHISKY MEASURE  
MEDIDOR PARA WHISKY

	Ref.	Un.	m <sup>3</sup>	7891116
Ø 6cm - 0,05l	61102/000	12	0,006	005323



NEW RELEASE  
LANZAMIENTO

COCKTAIL STRAINER  
COLADOR STRAINER PARA CÓCTEL

	Ref.	Un.	m <sup>3</sup>	7891116
	61347/100*	12	-	172957



NEW RELEASE  
LANZAMIENTO

JULEP COCKTAIL STRAINER  
COLADOR CUCHARA PARA CÓCTEL

	Ref.	Un.	m <sup>3</sup>	7891116
	61347/200*	12	-	172964





Zester  
Rallador de cítricos

Double-sided jigger  
Dosificador de bebidas doble

Spiral bar spoon  
Cuchara bailarina espiral

Boston shaker bottle with glass lid  
Coctelera boston con tapa de vidrio

Julep cocktail strainer  
Colador cuchara para cóctel

Jagged tip muddler  
Macerador punta dentada

Garnish tongs  
Pinza para decoraciones  
y guarniciones

Cocktail strainer  
Colador strainer para cóctel



NEW RELEASE  
LANZAMIENTO

SIEVE  
ZARANDA

	Ref.	Un.	m <sup>3</sup>	7891116
Ø 7,4cm	61347/110*	12	-	172971



NEW RELEASE  
LANZAMIENTO

JAGGED TIP MUDDLER  
MACERADOR PUNTA DENTADA

	Ref.	Un.	m <sup>3</sup>	7891116
22,4cm	61347/050*	12	-	172988



NEW RELEASE  
LANZAMIENTO

GARNISH TONGS  
PINZA PARA DECORACIONES  
Y GUARNICIONES

	Ref.	Un.	m <sup>3</sup>	7891116
24cm	63809/760*	12	-	173985



\* Imported Product / Producto Importado

Exclusive material for legal entities/corporate clients.  
Material exclusivo para clientes persona jurídica.



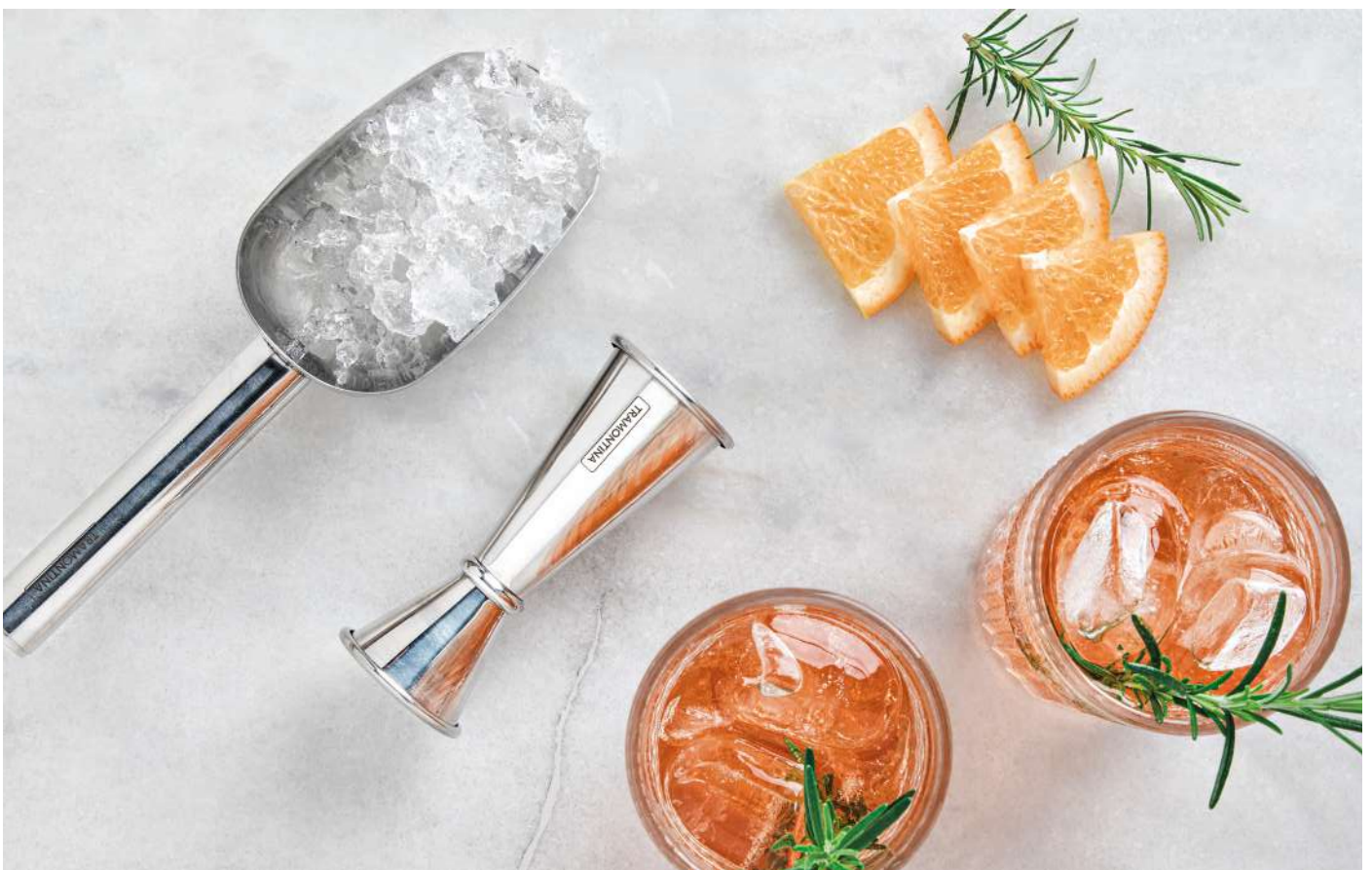



NEW RELEASE  
LANZAMIENTO



ICE SCOOP  
PINZA PARA HIELO

	Ref.	Un.	m <sup>3</sup>	7891116
0,10l	63809/610*	12	-	174005

NEW RELEASE  
LANZAMIENTO



ZESTER  
RALLADOR DE CÍTRICOS

	Ref.	Un.	m <sup>3</sup>	7891116
	63809/770*	12	-	173992

NEW RELEASE  
LANZAMIENTO



POUR SPOUT  
PICO REGULADOR

	Ref.	Un.	m <sup>3</sup>	7891116
	61347/010*	12	-	173954

NEW RELEASE  
LANZAMIENTO



LEMON SQUEEZER  
EXPRIMIDOR DE LIMÓN

	Ref.	Un.	m <sup>3</sup>	7891116
	61347/300*	06	-	173978

NEW RELEASE  
LANZAMIENTO



PVC BAR MAT  
ESTERILLA DE BAR PVC

	Ref.	Un.	m <sup>3</sup>	7891116
30x15cm	61347/210*	06	-	173022

NEW RELEASE  
LANZAMIENTO

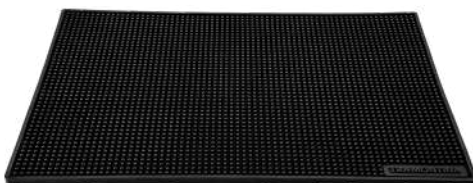

PVC BAR MAT  
ESTERILLA DE BAR PVC

	Ref.	Un.	m <sup>3</sup>	7891116
45x30cm	61347/220*	06	-	173039





NEW RELEASE  
LANZAMIENTO

**BOSTON SHAKER BOTTLE  
COCTELERA BOSTON**

	Ref.	Un.	m <sup>3</sup>	7891116
0,70l	61346/200*	06	-	173961



NEW RELEASE  
LANZAMIENTO

**BOSTON SHAKER BOTTLE WITH GLASS LID  
COCTELERA BOSTON CON TAPA DE VIDRIO**

	Ref.	Un.	m <sup>3</sup>	7891116
0,70l	61346/100*	06	-	173947



**COCKTAIL SHAKER  
COCTELERA**

	Ref.	Un.	m <sup>3</sup>	7891116
Ø 9cm - 0,68l	61346/080	06	0,017	023501

\* Imported Product / Producto Importado

Exclusive material for legal entities/corporate clients.  
Material exclusivo para clientes persona jurídica.







NEW RELEASE  
LANZAMIENTO

**SPIRAL BAR SPOON  
CUCHARA BAILARINA ESPIRAL**

	Ref.	Un.	m <sup>3</sup>	7891116
30cm	63999/300*	12	-	172995
45cm	63999/450*	12	-	173008



NEW RELEASE  
LANZAMIENTO

**SPIRAL BAR SPOON WITH DISC  
CUCHARA BAILARINA ESPIRAL CON DISCO**

	Ref.	Un.	m <sup>3</sup>	7891116
27cm	63999/500*	12	-	173015

\* Imported Product / Producto Importado





NEW RELEASE  
LANZAMIENTO

LONG DRINK SPOON  
CUCHARA PARA COQUETEL

	Ref.	Un.	m <sup>3</sup>	7891116
30cm	63960/525	12	0,003	174616



COCKTAIL SPOON  
CUCHARA PARA COQUETEL

	Ref.	Un.	m <sup>3</sup>	7891116
30cm	63999/525	12	0,002	053980
30cm	63999/524	24	0,003	118801



COCKTAIL SPOON  
CUCHARA PARA COQUETEL

	Ref.	Un.	m <sup>3</sup>	7891116
22cm	63939/200	12	0,004	033630
30cm	63939/520	12	0,002	025697





# STRAWS SORBETES

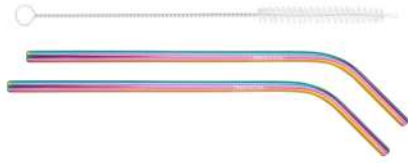

2 PC. COLORFUL STRAWS  
+ 1 PC. CLEANING BRUSH  
JUEGO DE SORBETES COLORIDOS 2 PZAS. +  
CEPILLO DE LIMPIEZA 1 PZA.

	Ref.	Un.	m <sup>3</sup>	7891116
Ø 0,60cm	64600/150*	06	0,004	155110



4 PC. COLORFUL STRAWS  
+ 1 PC. CLEANING BRUSH  
JUEGO DE SORBETES COLORIDOS 4 PZAS.  
+ CEPILLO DE LIMPIEZA 1 PZA.

	Ref.	Un.	m <sup>3</sup>	7891116
Ø 0,60cm	64600/133*	06	0,004	155103

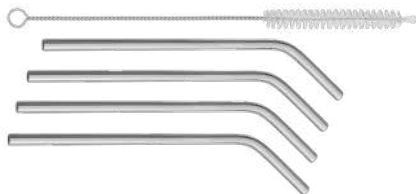

4 PC. STRAWS + 1 PC. CLEANING BRUSH  
JUEGO DE SORBETES 4 PZAS.  
+ CEPILLO DE LIMPIEZA 1 PZA.

	Ref.	Un.	m <sup>3</sup>	7891116
Ø 0,80cm	64600/160*	06	0,004	158388



Exclusive material for legal entities/corporate clients.  
Material exclusivo para clientes persona jurídica.

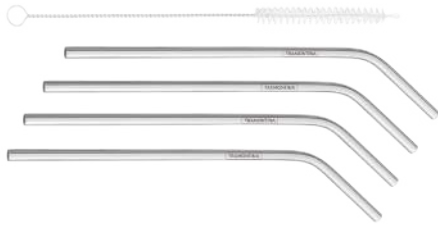

4 PC. STRAWS + 1 PC. CLEANING BRUSH  
 JUEGO DE SORBETES 4 PZAS. + CEPILLO DE LIMPIEZA 1 PZA.

	Ref.	Un.	m <sup>3</sup>	7891116
Ø 0,60cm	64600/130*	06	0,004	148686



1 PC. STRAW + 1 PC. CLEANING BRUSH  
 JUEGO DE SORBETE 1 PZA. + CEPILLO DE LIMPIEZA 1 PZA.

	Ref.	Un.	m <sup>3</sup>	7891116
Ø 0,60cm	64600/140*	06	0,002	148693



STRAW  
 SORBETE

	Ref.	Un.	m <sup>3</sup>	7891116
Ø 0,60cm	61344/000*	60	0,003	148662



CLEANING BRUSH  
 CEPILLO DE LIMPIEZA

	Ref.	Un.	m <sup>3</sup>	7891116
	61345/000*	30	0,003	148679



# BUCKETS BALDES

Ice bucket with handle and lid.  
Balde con tapa y asa.



Double wall construction keeps ice cold longer.  
Pared doble que conserva el hielo durante más tiempo.

Includes tongs that fit into lid.  
Viene con pinza para hielo, que se encaja en la tapa.

## INSULATED ICE SET JUEGO TÉRMICO PARA HIELO 2 PC./PZAS.

	Ref.	Un.	m <sup>3</sup>	7891116
Ø 14cm - 1,40l	64210/930**	04	0,030	052372

Contents / Contenido:  
1 Insulated Ice Bucket / Balde Térmico para Hielo  
1 Ice Tong / Pinza para Hielo



## ICE BUCKET HIELERA

	Ref.	Un.	m <sup>3</sup>	7891116
Ø 8cm - 0,56l	61219/081*	04	0,006	042755
Ø 10cm - 0,90l	61219/101*	04	0,013	042762
Ø 12cm - 1,55l	61219/120	04	0,015	035283
Ø 12cm - 1,55l	61219/121*	04	0,020	037218
Ø 14cm - 2,34l	61219/140	04	0,030	030981
Ø 14cm - 2,34l	61219/141*	04	0,024	037225



## ICE BUCKET HIELERA

	Ref.	Un.	m <sup>3</sup>	7891116
Ø 14cm - 1,86l	61319/140	02	0,012	050767

\* Plastic Bag / Bolsa Plástica  
\*\* Imported Product / Producto Importado

Exclusive material for legal entities/corporate clients.  
Material exclusivo para clientes persona jurídica.



TRAMONTINA



ICE TONG  
PINZA PARA HIELO

	Ref.	Un.	m <sup>3</sup>	7891116
	61343/000	24	0,015	022078



WINE/CHAMPAGNE BUCKET  
BALDE PARA BOTELLAS

	Ref.	Un.	m <sup>3</sup>	7891116
Ø 18,2cm - 5,28l	61218/180	04	0,056	030974
Ø 18,2cm - 5,28l	61218/181*	04	0,042	037201



WINE/CHAMPAGNE BUCKET  
BALDE PARA BOTELLAS

	Ref.	Un.	m <sup>3</sup>	7891116
Ø 20cm - 5,25l	61318/200	02	0,037	050750
Ø 20cm - 5,25l	61318/201*	04	0,035	050774



WINE/CHAMPAGNE BUCKET  
BALDE PARA BOTELLA

	Ref.	Un.	m <sup>3</sup>	7891116
Ø 20cm - 5,25l	61340/200	04	0,047	018736



STAND FOR WINE/CHAMPAGNE BUCKET  
SUPORTE CON ASTA PARA CHAMPAÑERA

	Ref.	Un.	m <sup>3</sup>	7891116
260 x 260 x 585 mm	61106/000*	01	0,049	006849

\* Plastica Bag / Bolsa Plástica





CHAMPAGNE COOLER WITH  
STAND FOR 4 BOTTLES  
CHAMPAÑERA CON ANILLOS  
PARA SUJETAR 4 BOTELLAS

	Ref.	Un.	m <sup>3</sup>	7891116
Ø 42cm - 11,90l	61276/420	01	0,047	009741



CHAMPAGNE COOLER  
CHAMPAÑERA

	Ref.	Un.	m <sup>3</sup>	7891116
Ø 36cm - 12,48l	61415/360	03	0,145	060421



CHAMPAGNE COOLER WITH STAND FOR  
4 BOTTLES  
CHAMPAÑERA CON ANILLOS PARA SUJE-  
TAR 4 BOTELLAS

	Ref.	Un.	m <sup>3</sup>	7891116
Ø 36cm - 12,48l	61414/360	03	0,145	060094









COASTER SET  
 JUEGO DE PORTAVASOS  
 6 PC./PZAS.

	Ref.	Un.	m <sup>3</sup>	7891116
Ø 12,3cm	64210/900	08	0,030	004043



HOR'S D'OEUVRE DISH  
 ENTREMESERA 3 CAVIDADES

	Ref.	Un.	m <sup>3</sup>	7891116
Ø 17,3cm	61426/170	20	0,017	008973



HOR'S D'OEUVRE DISH  
 ENTREMESERA 5 CAVIDADES

	Ref.	Un.	m <sup>3</sup>	7891116
369 x 315mm	61338/360	06	0,030	001547

# CHILDREN INFANTIL

---



Exclusive material for legal entities/corporate clients.  
Material exclusivo para clientes persona jurídica.

## SAFE DESIGN

# FUN AT THE TABLE

The full development of any child includes experiencing and learning from mealtimes. With this in mind, Tramontina offers a children's line with products that stimulate the little ones' senses and favor a healthy interaction with food.

The stainless steel ensures safe handling and the designs involve the children in a light-hearted and fun experience at the table.

## DISEÑO SEGURO

# MÁS DIVERSIÓN EN LA MESA

El desarrollo pleno de cualquier niño también pasa por las experiencias y aprendizajes en las comidas. Pensando en eso, Tramontina ofrece una línea infantil con productos que estimulan los sentidos de los peques y favorecen un contacto sano con los alimentos.

El acero inoxidable garantiza la seguridad en el manejo, mientras los estampados involucran al niño en una experiencia liviana y más divertida en la mesa.





# Allegria

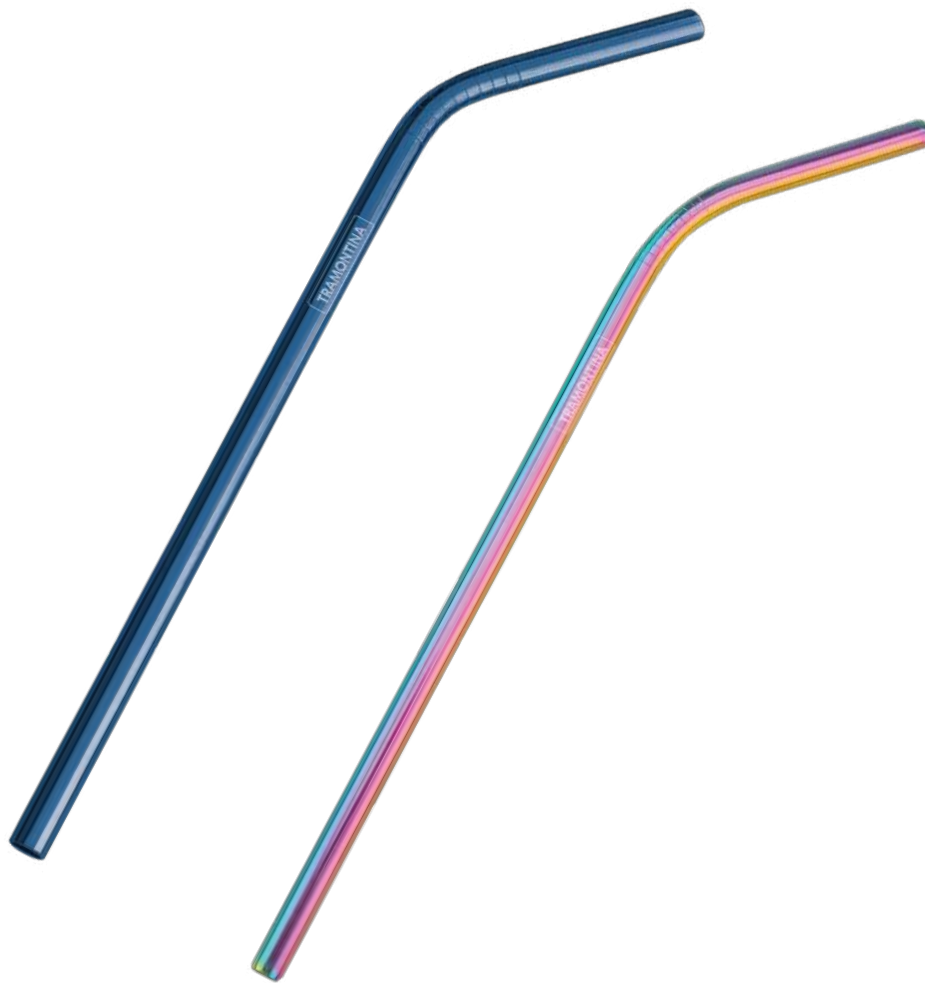

The Allegria Line of stainless steel straws inspires fun moments while taking the care for the environment seriously.

They are resistant items, easy to clean and still give a colorful touch to the table.

**STAINLESS STEEL**

La línea Allegria de sorbete de acero inoxidable inspira momentos divertidos mientras se toma en serio el cuidado del medio ambiente.

Son artículos resistentes, fáciles de limpiar y que aún dan un toque colorido a la mesa.

**ACERO INOXIDABLE**



1 PC. KIDS STRAW + 1 PC. CLEANING  
BRUSH  
SORBETE PARA NIÑO 1 PZA. + CEPILLO  
DE LIMPIEZA 1 PZA.

Ref.	Un.	m <sup>2</sup>	7891116
64600/144*	06	0,002	155363



1 PC. KIDS STRAW + 1 PC. CLEANING  
BRUSH  
SORBETE PARA NIÑO 1 PZA. + CEPILLO  
DE LIMPIEZA 1 PZA.

Ref.	Un.	m <sup>2</sup>	7891116
64600/145*	06	0,002	155370

\* Imported Product / Producto Importado

Exclusive material for legal entities/corporate clients.  
Material exclusivo para clientes persona jurídica.

# Lellos



Fun will run wild with the Lellos flatware line.

These resistant products are made of stainless steel with little animals engraved in relief on the handle.

To fill tummies with so much cuteness.

**STAINLESS STEEL**

La diversión va a comer, literalmente, a gusto con la línea de cubiertos Lellos.

Resistentes, las piezas se hacen en acero inoxidable y tienen bichitos grabados en alto relieve en el mango.

Es para llenar la barriguita con mucha dulzura.

**ACERO INOXIDABLE**





**CHILD'S FLATWARE SET  
JUEGO DE CUBIERTOS PARA NIÑOS  
3 PC./PZAS.**

Ref.	Un.	m <sup>2</sup>	7891116
66975/000	10	0,012	148341

Contents / Contenido:  
 1 Spoon / Cuchara  
 1 Fork / Tenedor  
 1 Knife / Cuchillo

# Le Petit



Le Petit line will accompany the little ones in their first few years of life.

The flatware items have options for infants who are still on baby food and also for those who are a little older and can feed themselves.

Delicate and ergonomical, the items have motifs that allude to the sweetest phase of childhood.

**STAINLESS STEEL**  
**HIGH-RELIEF DETAILS**

La línea Le Petit va a acompañar a los pequeños en sus primeros añitos de vida.

Los cubiertos tienen opciones para los peques que están todavía en la etapa de los purés y también para los más grandecitos, que ya comen solitos.

Delicadas y anatómicas, las piezas traen motivos alusivos a la época más dulce de la infancia.

**ACERO INOXIDABLE**  
**DETALLES EN ALTO RELIEVE**



**KIDS VACUUM INSULATED BOTTLE  
TERMO INFANTIL  
350ml**

Ref.	Un.	m <sup>3</sup>	7891116
61649/035*	04	0,005	140079



**KIDS VACUUM INSULATED FOOD JAR  
TERMO INFANTIL PARA ALIMENTOS**

Ref.	Un.	m <sup>3</sup>	7891116
61648/045*	04	0,007	140055



**CHILD'S SET  
JUEGO PARA NIÑOS  
4 PC./PZAS.**

Ref.	Un.	m <sup>3</sup>	7891116
64250/615	05	0,025	170113

Contents / Contenido:  
 1 Spoon / Cuchara  
 1 Fork / Tenedor  
 1 Bib / Babero  
 1 Mixing bowl with plastic lid /  
 Recipiente con tapa plástica  
 Ø 9 cm 0,30l





Exclusive material for legal entities/corporate clients.  
Material exclusivo para clientes persona jurídica.



CHILD'S DISH  
PLATO PARA NIÑOS  
1 PC./PZA.

	Ref.	Un.	m <sup>3</sup>	7891116
Ø 23cm	61257/235	10	0,027	074190



CHILD'S FLATWARE SET  
JUEGO DE CUBIERTOS PARA NIÑOS  
2 PC./PZAS.

	Ref.	Un.	m <sup>3</sup>	7891116
	66973/015	12	0,013	075517

Contents / Contenido:  
1 Spoon / Cuchara  
1 Fork / Tenedor



CHILD'S FLATWARE SET  
JUEGO DE CUBIERTOS PARA NIÑOS  
3 PC./PZAS.

	Ref.	Un.	m <sup>3</sup>	7891116
	66973/005	12	0,013	075494

Contents / Contenido:  
1 Spoon / Cuchara  
1 Fork / Tenedor  
1 Knife / Cuchillo



CHILD'S SET  
JUEGO PARA NIÑOS  
2 PC./PZAS.

Ref.	Un.	m <sup>3</sup>	7891116
64250/635	12	0,013	123706

Contents / Contenido:  
1 Baby Bib / Babero Bandana  
1 Spoon / Cuchara



CHILD'S SET  
JUEGO PARA NIÑOS  
3 PC./PZAS.

Ref.	Un.	m <sup>3</sup>	7891116
64250/655	05	0,015	075531

Contents / Contenido:  
1 Bowl / Plato Redondo  
1 Spoon / Cuchara  
1 Bib / Babero



CHILD'S SET  
JUEGO PARA NIÑOS  
6 PC./PZAS.

Ref.	Un.	m <sup>3</sup>	7891116
64250/645	04	0,035	075555

Contents / Contenido:  
1 Child's Dish / Plato para Niños - Ø 23cm  
1 Cup / Vaso - 0,20l  
1 Knife / Cuchillo  
1 Fork / Tenedor  
1 Spoon / Cuchara  
1 Bib / Babero





KIDS VACUUM INSULATED BOTTLE  
TERMO INFANTIL  
350ml

Ref.	Un.	m <sup>3</sup>	7891116
61649/030*	04	0,006	140062



KIDS VACUUM INSULATED FOOD JAR  
TERMO INFANTIL PARA ALIMENTOS

	Ref.	Un.	m <sup>3</sup>	7891116
Ø 8,8cm - 400ml	61648/040*	04	0,007	140048

\* Imported Product / Producto Importado



**CHILD'S SET  
JUEGO PARA NIÑOS  
4 PC./PZAS.**

Ref.	Un.	m <sup>3</sup>	7891116
64250/610	05	0,025	170120

Contents / Contenido:  
 1 Spoon / Cuchara  
 1 Fork / Tenedor  
 1 Bib / Babero  
 1 Mixing bowl with plastic lid /  
 Recipiente con tapa plástica  
 Ø 9 cm 0,30l





CHILD'S DISH  
PLATO PARA NIÑOS  
1 PC./PZA.

	Ref.	Un.	m <sup>3</sup>	7891116
Ø 23cm	61257/230	10	0,027	074183



CHILD'S FLATWARE SET  
JUEGO DE CUBIERTOS PARA NIÑOS  
2 PC./PZAS.

	Ref.	Un.	m <sup>3</sup>	7891116
	66973/010	12	0,013	075500

Contents / Contenido:  
1 Spoon / Cuchara  
1 Fork / Tenedor



CHILD'S FLATWARE SET  
JUEGO DE CUBIERTOS PARA NIÑOS  
3 PC./PZAS.

	Ref.	Un.	m <sup>3</sup>	7891116
	66973/000	12	0,013	075487

Contents / Contenido:  
1 Spoon / Cuchara  
1 Fork / Tenedor  
1 Knife / Cuchillo



CHILD'S SET  
JUEGO PARA NIÑOS  
2 PC./PZAS.

	Ref.	Un.	m <sup>3</sup>	7891116
	64250/660	04	0,017	086896

Contents / Contenido:  
1 Bowl / Vasija  
1 Spoon / Cuchara





CHILD'S SET  
JUEGO PARA NIÑOS  
2 PC./PZAS.

Ref.	Un.	m <sup>3</sup>	7891116
64250/630	12	0,013	123690

Contents / Contenido:  
1 Baby Bib / Babero Bandana  
1 Spoon / Cuchara



CHILD'S SET  
JUEGO PARA NIÑOS  
3 PC./PZAS.

Ref.	Un.	m <sup>3</sup>	7891116
64250/650	05	0,015	075524

Contents / Contenido:  
1 Bowl / Plato Redondo  
1 Spoon / Cuchara  
1 Bib / Babero



CHILD'S SET  
JUEGO PARA NIÑOS  
5 PC./PZAS.

Ref.	Un.	m <sup>3</sup>	7891116
64250/620	04	0,045	149621

Contents / Contenido:  
1 Spoon / Cuchara  
1 Fork / Tenedor  
1 Round Deep Dish / Plato  
1 Cup / Taza - 0,25l  
1 Bowl / Vasija



CHILD'S SET  
JUEGO PARA NIÑOS  
6 PC./PZAS.

Ref.	Un.	m <sup>3</sup>	7891116
64250/640	04	0,035	075548

Contents / Contenido:  
1 Child's Dish / Plato para Niños - Ø 23cm  
1 Cup / Vaso - 0,20l  
1 Knife / Cuchillo  
1 Fork / Tenedor  
1 Spoon / Cuchara  
1 Bib / Babero



#### DISPLAY LE PETIT

	Ref.	Un.	m <sup>3</sup>	7891116
3 Pc./Pzas.	66973/100	40	0,035	079287
2 Pc./Pzas.	66973/110	40	0,035	079294

Contents / Contenido:  
 20 Sets for Boys / Juegos para Niños  
 20 Sets for Girls / Juegos para Niñas

Available with sets of 3 and 2  
 children's cutlery pieces.  
 Disponible con juego de 3 y 2  
 cubiertos infantiles.



# Baby Friends



One of Tramontina's most traditional lines, Baby has now become a classic.

This collection offers flatware, plates and cups for children.

The highlight is the curved spoon, adapted for children's motor skills.

**STAINLESS STEEL**  
**HIGH-RELIEF DETAILS**

Una de las líneas más tradicionales de Tramontina Baby, ya se ha convertido en un clásico.

La colección presenta cubiertos, platos y vasos infantiles.

La destacada es la cuchara con diseño curvado, adaptada a la motricidad de los pequeños.

**ACERO INOXIDABLE**  
**DETALLES EN ALTO RELIEVE**







**CHILD'S CURVERED SPOON  
CUCHARA PARA NIÑOS**

Ref.	Un.	m <sup>3</sup>	7891116
66970/000	12	0,007	001936



**CHILD'S FLATWARE SET  
JUEGO DE CUBIERTOS PARA NIÑOS  
2 PC./PZAS.**

Ref.	Un.	m <sup>3</sup>	7891116
66970/030	15	0,013	001271

Contents / Contenido:  
1 Spoon / Cuchara  
1 Fork / Tenedor



**CHILD'S FLATWARE SET  
JUEGO DE CUBIERTOS PARA NIÑOS  
3 PC./PZAS.**

Ref.	Un.	m <sup>3</sup>	7891116
66970/020	12	0,013	000410

Contents / Contenido:  
1 Spoon / Cuchara  
1 Fork / Tenedor  
1 Knife / Cuchillo



**CHILD'S FLATWARE SET  
JUEGO DE CUBIERTOS PARA NIÑOS  
4 PC./PZAS.**

Ref.	Un.	m <sup>3</sup>	7891116
66970/010	10	0,013	000489

Contents / Contenido:  
1 Spoon / Cuchara  
1 Curvered Spoon / Cuchara para Niños  
1 Fork / Tenedor  
1 Knife / Cuchillo



CHILD'S CUP  
VASO PARA NIÑO

	Ref.	Un.	m <sup>3</sup>	7891116
Ø 7cm - 0,34l	61417/071*	06	0,005	144671



CHILD'S CUP  
VASO PARA NIÑO

	Ref.	Un.	m <sup>3</sup>	7891116
Ø 7cm - 0,34l	61251/075	12	0,013	168806



CHILD'S ROUND DISH  
PLATO PARA NIÑOS

	Ref.	Un.	m <sup>3</sup>	7891116
Ø 23cm	61254/235	12	0,027	168813



CHILD'S SET  
JUEGO PARA NIÑOS  
5 PC./PZAS.

	Ref.	Un.	m <sup>3</sup>	7891116
	64250/755	06	0,061	168790

Contents / Contenido:  
 1 Child's Dish / Plato para Niños  
 1 Cup / Vaso Ø 7cm - 0,34l  
 1 Spoon / Cuchara  
 1 Fork / Tenedor  
 1 Knife / Cuchillo



SPOON  
CUCHARA

	Ref.	Un.	m <sup>3</sup>	7891116
	63970/015	120	0,023	074305



Individual cutlery tag.  
Blister de los cubiertos individuales.

FORK  
TENEDOR

	Ref.	Un.	m <sup>3</sup>	7891116
	63970/025	120	0,023	074312

KNIFE  
CUCHILLO

	Ref.	Un.	m <sup>3</sup>	7891116
	63970/035	120	0,023	074329

\*No packaging / Sin embalaje



# HOSPITALITY

---



Exclusive material for legal entities/corporate clients.  
Material exclusivo para clientes persona jurídica.

**SERVICE OF EXCELLENCE**

# IDEAL PRODUCTS FOR PROFESSIONALS

Efficiency, reliability and safety are essential for the success of those who are in the food business. This is why Tramontina offers the Business line, with utensils and equipment that perform beautifully in bars, restaurants, hotels and other establishments.

More than simply for serving well, these items allow you to work with high performance and convenience from preparing to serving.

**SERVICIO DE EXCELENCIA**

# PRODUCTOS IDEALES PARA PROFESIONALES

Eficiencia, confiabilidad y seguridad son requisitos para el éxito de los que hacen de la comida un negocio. Es por eso que Tramontina ofrece la línea Empresarial, con utensilios y equipos que se lucen en bares, restaurantes, hoteles y otros establecimientos.

Más que atender bien, los artículos permiten trabajar con un alto desempeño y practicidad desde el momento de preparar hasta el de servir.



# CHAFING DISHES RECHAUDS



2/3

CHAFING DISH  
RECHAUD  
475 X 410 X 170 MM  
5,50L

Ref.	Un.	m <sup>3</sup>	7891116
**61027/010	01	0,053	149850

Without support, to be used in induction heating bases.  
Water recipient of triple layer body.  
Rechaud sin base para ser utilizado en bases de calentamiento por inducción.  
Cuba de agua con acero de cuerpo triple.



2/3

STAND FOR 2/3 CHAFING DISH  
SOPORTE PARA RECHAUD 2/3

Ref.	Un.	m <sup>3</sup>	7891116
*61027/020	01	0,046	149867



2/3

STAND FOR 2/3 CHAFING DISH  
SOPORTE PARA RECHAUD 2/3

Ref.	Un.	m <sup>3</sup>	7891116
**61027/023	01	0,046	149874



1/1

CHAFING DISH  
RECHAUD  
580 X 475 X 170 MM  
11,20L

Ref.	Un.	m <sup>3</sup>	7891116
**61026/010	01	0,069	149805

Without support, to be used in induction heating bases.  
Water recipient of tri-ply stainless steel.  
Rechaud sin base para ser utilizado en bases de calentamiento por inducción.  
Cuba de agua con acero de cuerpo triple.

\* With heater | Con brasero.  
\*\* Without heater | Sin brasero





1/1

STAND FOR 1/1 CHAFING DISH  
SOPORTE PARA RECHAUD 1/1

Ref.	Un.	m <sup>3</sup>	7891116
*61026/020	01	0,062	149812



1/1

STAND FOR 1/1 CHAFING DISH  
SOPORTE PARA RECHAUD 1/1

Ref.	Un.	m <sup>3</sup>	7891116
**61026/023	01	0,062	149829



220V / 60Hz / 600W

PORTABLE INDUCTION COOKTOP  
PLACA DE INDUCCIÓN PORTÁTIL  
40 X 40CM

Ref.	Un.	m <sup>3</sup>	7891116
61039/420	02	0,067	143001



220V / 60Hz / 600W

SERVING SET  
JUEGO PARA SERVIR  
5 PC. / PZAS.

Ref.	Un.	m <sup>3</sup>	7891116
64039/420	01	0,067	160107

1 Portable induction cooktop / Placa de inducción portátil 40x40cm  
1 Square pot / Olla cuadrada  
1 Serving spoon / Cuchara para servir  
1 Lid support / Soporte para tapa  
1 Utensil holder / Apoyo para utensilios

ROLL TOP CHAFER  
RECHAUD CON TAPA BASCULANTE

Ø 50 cm - 6,50l

Perfect for buffets,  
parties and more formal  
occasions.  
Perfecto para buffets,  
fiestas y eventos más  
sofisticados.



Made of stainless steel, does not leave  
residue on food.  
Pieza de acero inoxidable, no suelta  
residuos en los alimentos.

	Ref.	Un.	m <sup>3</sup>	7891116
Heater   Brasero	61021/010	01	0,121	069288
220V	61021/012*	01	0,121	069967

ROLL TOP CHAFER  
RECHAUD CON TAPA BASCULANTE  
9,06L



1/1

	Ref.	Un.	m <sup>3</sup>	7891116
Heater   Brasero	61043/010	01	0,122	030950
220V	61043/012*	01	0,122	033593
220V	61043/017**	01	0,122	039342

8,42L

1/2 1/2

	Ref.	Un.	m <sup>3</sup>	7891116
Heater   Brasero	61043/020	01	0,122	030967
220V	61043/022*	01	0,122	033616
220V	61043/027**	01	0,122	039359

CHAFING DISH WITH REMOVABLE LID  
RECHAUD CON TAPA MÓVIL  
9,06L



1/1

	Ref.	Un.	m <sup>3</sup>	7891116
Heater   Brasero	61047/010	01	0,087	060735
220V	61047/012*	01	0,081	097915

8,42L

1/2 1/2

	Ref.	Un.	m <sup>3</sup>	7891116
Heater   Brasero	61047/020	01	0,081	097939
220V	61047/022*	01	0,081	097953

\*Type 10A plug outlet (Brazilian standard)  
\*Enchufe tipo 10A (estándar Brasileño)



\*\*Type F plug outlet (European standard)  
\*\*Enchufe tipo F (estándar europeo)





1/1

CHAFING DISH WITH REMOVABLE LID  
RECHAUD CON TAPA MÓVIL  
9,06L

Ref.	Un.	m <sup>3</sup>	7891116
61048/076	01	0,067	084359



1/1

CHAFING DISH WITH REMOVABLE LID  
RECHAUD CON TAPA MÓVIL  
9,06L

Ref.	Un.	m <sup>3</sup>	7891116
61040/276	01	0,073	097342

Without fuel o cans  
Sin quemador



1/1

CHAFING DISH WITH REMOVABLE LID  
RECHAUD CON TAPA MÓVIL  
9,06L

	Ref.	Un.	m <sup>3</sup>	7891116
Heater   Brasero	61040/210	01	0,077	090121
127V	61040/211*	01	0,077	090138
220V	61040/212*	01	0,077	090145
220V	61040/217**	01	0,077	090152

8,42L

1/2 1/2

	Ref.	Un.	m <sup>3</sup>	7891116
Heater   Brasero	61040/220	01	0,077	097823
127V	61040/221*	01	0,077	097830
220V	61040/222*	01	0,077	097847



1/1

CHAFING DISH WITH HINGED LID  
RECHAUD CON TAPA RETRÁCTIL  
9,06L

	Ref.	Un.	m <sup>3</sup>	7891116
Heater   Brasero	61045/010	01	0,087	047286
220V	61045/012*	01	0,087	047309
220V	61045/017**	01	0,087	047316

8,42L

1/2 1/2

	Ref.	Un.	m <sup>3</sup>	7891116
Heater   Brasero	61045/020	01	0,087	047323
220V	61045/022*	01	0,087	047347

\*Type 10A plug outlet (Brazilian standard)  
\*Enchufe tipo 10A (estándar Brasileño)

Exclusive material for legal entities/corporate clients.  
Material exclusivo para clientes persona jurídica.

\*\*Type F plug outlet (european standard)  
\*\*Enchufe tipo F (estándar europeo)





Exclusive material for legal entities/corporate clients.  
Material exclusivo para clientes persona jurídica.



CHAFING DISH WITH REMOVABLE LID  
RECHAUD CON TAPA MÓVIL

	Ref.	Un.	m <sup>3</sup>	7891116
Heater   Brasero	61045/210	01	0,080	160039



ROUND CHAFING DISH  
RECHAUD REDONDO  
Ø 28cm - 4,30l

	Ref.	Un.	m <sup>3</sup>	7891116
Heater   Brasero	61041/200	01	0,045	149270
127V	61041/211*	01	0,045	149294
220V	61041/212*	01	0,045	149300



ROUND CHAFING DISH  
RECHAUD REDONDO  
Ø 28cm - 7,00l

	Ref.	Un.	m <sup>3</sup>	7891116
Heater   Brasero	61042/200	01	0,045	149317
127V	61042/211*	01	0,045	149331
220V	61042/212*	01	0,045	149348



ROUND CHAFING DISH  
RECHAUD REDONDO  
Ø 28cm - 4,30l

	Ref.	Un.	m <sup>3</sup>	7891116
Heater   Brasero	61041/000	01	0,037	024461



ROUND CHAFING DISH  
RECHAUD REDONDO  
Ø 28cm - 7,00l

	Ref.	Un.	m <sup>3</sup>	7891116
Heater   Brasero	61042/000	01	0,043	024478



CHAFING DISH  
RECHAUD  
SOLAR

	Ref.	Un.	m <sup>3</sup>	7891116
Ø 24cm - 6,10l	65500/670	01	0,022	030226
Ø 24cm - 7,80l	65500/680	01	0,022	032244



CHAFING DISH  
RECHAUD  
ALLEGRA

	Ref.	Un.	m <sup>3</sup>	7891116
Ø 24cm - 7,50l	65650/680	01	0,031	067383

CHAFING DISH WITH GLASS LID  
RECHAUD CON TAPA DE VIDRIO  
ALLEGRA

	Ref.	Un.	m <sup>3</sup>	7891116
Ø 24cm - 7,50l	65650/684	01	0,030	075586





Exclusive material for legal entities/corporate clients.  
Material exclusivo para clientes persona jurídica.

# SPARE PARTS AND COMPLEMENTS REPUESTOS Y COMPLEMENTOS



WATER CONTAINER  
RECIPIENTE PARA BAÑO MARIA

	Ref.	Un.	m <sup>3</sup>	7891116
Ø 30cm - 1,50l	61041/120	01	0,028	034286
Ø 30cm - 1,80l	61042/120	01	0,028	034293



HEATING ELEMENT FOR ROUND BOWL  
RESISTENCIA ELÉCTRICA PARA  
FUENTE REDONDA - 220W  
4,30l - 7,00l

	Ref.	Un.	m <sup>3</sup>	7891116
127V - 2,0A	61041/810	01	0,006	047675
220V - 1,0A	61041/820	01	0,006	047682

HEATING ELEMENT FOR RECTANGULAR  
BOWL  
RESISTENCIA ELÉCTRICA PARA  
FUENTE RECTANGULAR - 350W  
2/3 - 1/1

	Ref.	Un.	m <sup>3</sup>	7891116
127V - 4,1A	61030/810	01	0,006	047644
220V - 2,0A	61030/820	01	0,006	047651

The Heating Element of the chaf dishes has a thermostat that keeps the water heating temperature in the range between 80 and 90 degrees Celsius. Furthermore, it avoids overheat in case of water shortage in the external container.

La resistencia de los rechauds posee termostato, que mantiene la temperatura de calentamiento del agua entre los 80 a 90 grados Celsius. Además de eso, evita un sobrecalentamiento cuando falta agua en la cuba externa.

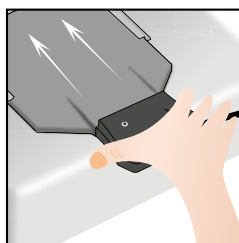

to fit  
encajar

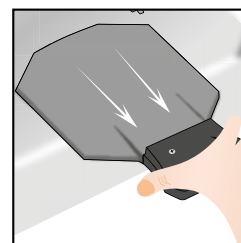

to remove  
sacar



# GASTRONORM LIDS TAPAS GASTRONÓMICAS



## WITHOUT SLOT SIN RECORTES

	Ref.	Un.	m <sup>3</sup>	7891116
1/4	61093/140	10	0,012	019566
1/6	61093/160	20	0,017	019450
1/9	61093/190	20	0,009	013847
2/1	61093/210	05	0,137	018330
2/3	61093/230	10	0,030	019559
2/4	61093/240	10	0,037	018699
2/8	61093/280	10	0,015	019078



## WITHOUT SLOT SIN RECORTES

	Ref.	Un.	m <sup>3</sup>	7891116
1/1	61093/110	10	0,054	017968
1/2	61093/120	10	0,023	017975
1/3	61093/130	10	0,023	019085



## WITH SLOT FOR SOUP LADLE CON RECORTE PARA CAZO DE SOPA

	Ref.	Un.	m <sup>3</sup>	7891116
1/1	61094/110	10	0,054	021590
1/2	61094/120	10	0,023	021606
1/3	61094/130	10	0,023	021613
1/4	61094/140	10	0,012	021620
1/6	61094/160	20	0,017	021637
2/1	61094/210	05	0,137	021651
2/3	61094/230	10	0,030	021668
2/4	61094/240	10	0,037	021675
2/8	61094/280	10	0,023	021682

110 mm



## WITH SLOT ON THE SIDE HANDLES CON RECORTE PARA ASAS

	Ref.	Un.	m <sup>3</sup>	7891116
1/1	61095/110	10	0,054	013854
1/2	61095/120	10	0,023	013861
1/3	61095/130	10	0,023	013878
1/4	61095/140	10	0,012	013885
1/6	61095/160	20	0,017	013892
2/1	61095/210	05	0,137	019429
2/3	61095/230	10	0,030	013908
2/4	61095/240	10	0,037	021699
2/8	61095/280	10	0,023	021705





WITH SLOT SIDE HANDLES  
AND SOUP LADLE  
CON RECORTE PARA ASAS  
Y CAZO DE SOPA

	Ref.	Un.	m <sup>3</sup>	7891116
1/1	61096/110	10	0,054	021712
1/2	61096/120	10	0,023	021729
1/3	61096/130	10	0,023	021736
1/4	61096/140	10	0,012	021743
1/6	61096/160	20	0,017	021750
2/1	61096/210	05	0,137	021767
2/3	61096/230	10	0,030	021774
2/4	61096/240	10	0,037	021781
2/8	61096/280	10	0,023	021798



GASTRONORM LID  
TAPA GASTRÓNOMICA  
1/1

	Ref.	Un.	m <sup>3</sup>	7891116
	61093/115	06	0,082	110546

6 units per display box / Caja display con 6 unidades



GASTRONORM LID  
TAPA GASTRÓNOMICA  
1/3

	Ref.	Un.	m <sup>3</sup>	7891116
	61093/135	06	0,020	110560

6 units per display box / Caja display con 6 unidades



GASTRONORM LID  
TAPA GASTRONÓMICA  
1/6

Ref.	Un.	m <sup>3</sup>	7891116
61093/165	10	0,017	110577



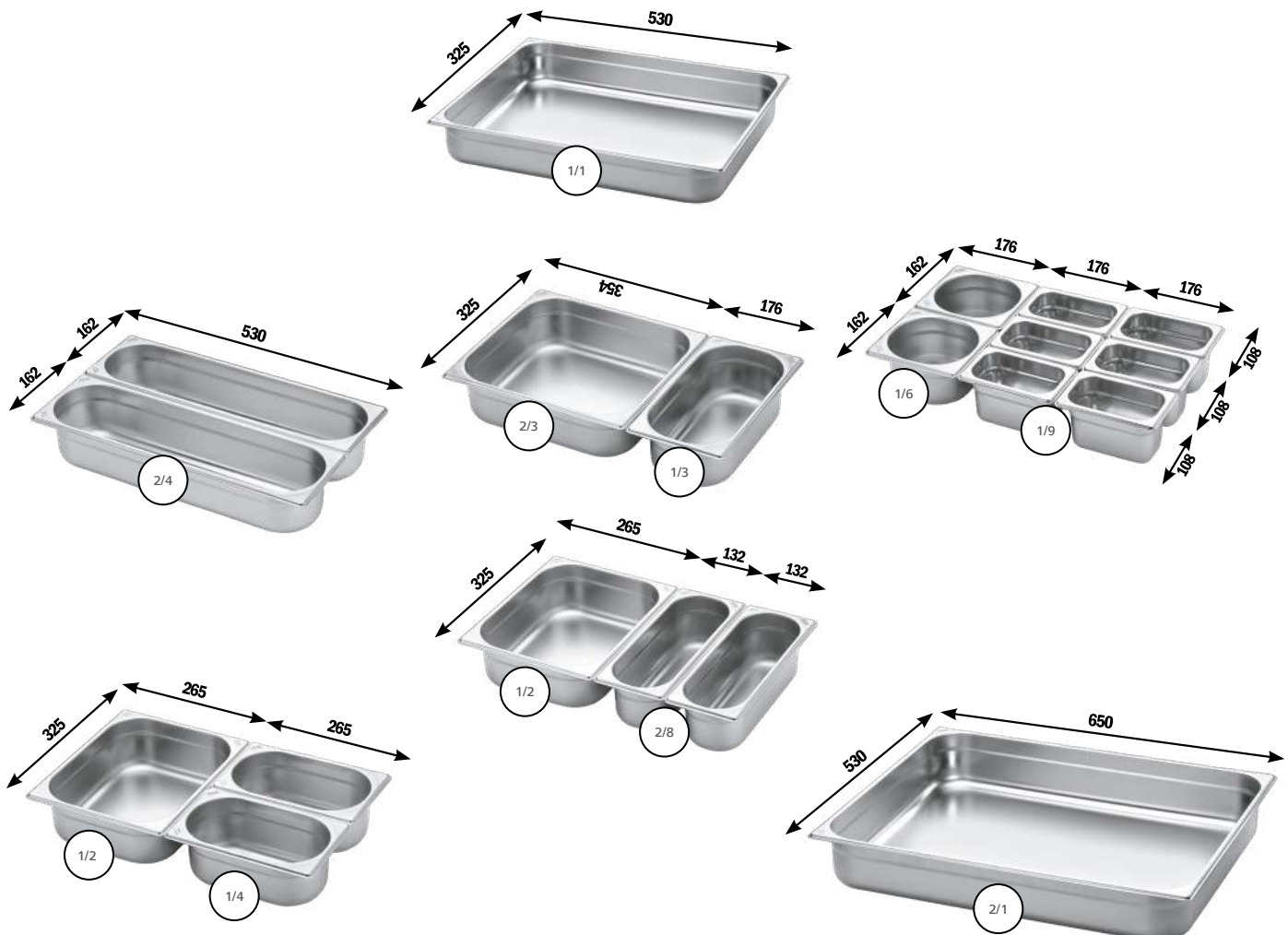

10 units per display box / Caja display con 10 unidades

The range of Tramontina Gastronorm Containers are made according to every dimensions modules described in the European Standard EN 631, in the depths of 20, 40, 65, 100, 150, 180 and 200mm. The basic measure of the Gastronomic System is made by the boel model 1/1, with external dimensions of 530x325mm. The other models are multiple (2/1) or a fraction of the same bowl (2/3, 1/2, 2/4, 1/3, 1/4, 2/8, 1/6, 1/9). See the dimensions reported on the diagram below.

La gama de Fuentes Tramontina, está de acuerdo con todos los módulos dimensionados descritos bajo una norma europea EN 631, en las profundidades de 20, 40, 65, 100, 150, 180 y 200 mm. La medida base del sistema Gastronomic es constituida por la cubeta modelo 1/1 de dimensiones externas 530x325 mm. Los otros modelos son multiples (2/1) y fracción del mismo (2/3, 1/2, 2/4, 1/3, 1/4, 2/8, 1/6, 1/9). Vea las dimensiones diagramadas abajo:



# GASTRONORM CUBAS GASTRONÓMICAS

	External measures Medidas externas	Thickness Espesor	Cap.	Prof.	Un.	m <sup>3</sup>	Without handles Sin asas	With handles Con asas
	Internal measures Medidas internas							
	2/1 650 x 530mm 625 x 505mm	0,8mm	5,42l	20mm	10	0,137	61050/020	-
		0,8mm	5,42l	20mm	10	0,137	61050/022	-
		0,8mm	11,70l	40mm	05	0,137	61050/040	-
		0,8mm	11,70l	40mm	05	0,137	61050/042	-
		0,7mm	19,06l	65mm	05	0,137	61050/060	61060/060
		0,7mm	19,06l	65mm	05	0,137	61050/062	61060/062
		0,8mm	29,50l	100mm	05	0,137	61050/100	61060/100
		0,8mm	29,50l	100mm	05	0,137	61050/102	61060/102
		0,8mm	45,40l	150mm	01	0,137	61050/150	61060/150
		0,8mm	45,40l	150mm	01	0,137	61050/152	61060/152
		0,8mm	53,60l	180mm	01	0,137	61050/180	61060/180
		0,8mm	53,60l	180mm	01	0,137	61050/182	61060/182
	1/1 530 x 325mm 505 x 300mm	0,5mm	2,50l	20mm	10	0,014	61051/020	-
		0,5mm	2,50l	20mm	10	0,014	61051/022	61061/062
		0,5mm	5,35l	40mm	10	0,014	61051/040	-
		0,5mm	5,35l	40mm	10	0,014	61051/042	-
		0,5mm	9,06l	65mm	10	0,070	61051/060	61061/060
		0,5mm	9,06l	65mm	10	0,070	61051/062	-
		0,5mm	14,0l	100mm	10	0,070	61051/100	61061/100
		0,5mm	14,0l	100mm	10	0,070	61051/102	61061/102
		0,6mm	20,70l	150mm	10	0,137	61051/150	61061/150
		0,6mm	20,70l	150mm	10	0,137	61051/152	61061/152
		0,7mm	25,0l	180mm	10	0,137	61051/180	61061/180
		0,7mm	25,0l	180mm	10	0,137	61051/182	61061/182
	2/3 354 x 325mm 329 x 300mm	0,5mm	1,70l	20mm	10	0,010	61052/020	-
		0,5mm	1,70l	20mm	10	0,010	61052/022	-
		0,5mm	3,40l	40mm	10	0,010	61052/040	-
		0,5mm	3,40l	40mm	10	0,010	61052/042	-
		0,5mm	5,90l	65mm	10	0,040	61052/060	61062/060
		0,5mm	5,90l	65mm	10	0,040	61052/062	61062/062
		0,5mm	8,86l	100mm	10	0,049	61052/100	61062/100
		0,5mm	8,86l	100mm	10	0,049	61052/102	61062/102
		0,6mm	13,38l	150mm	10	0,070	61052/150	61062/150
		0,6mm	13,38l	150mm	10	0,070	61052/152	61062/152
		0,7mm	15,96l	180mm	10	0,070	61052/180	61062/180
		0,7mm	15,96l	180mm	10	0,070	61052/182	61062/182
	1/2 325 x 265mm 300 x 240mm	0,5mm	1,18l	20mm	20	0,015	61053/020	-
		0,5mm	1,18l	20mm	20	0,015	61053/022	-
		0,5mm	2,43l	40mm	20	0,015	61053/040	-
		0,5mm	2,43l	40mm	20	0,015	61053/042	-
		0,5mm	4,21l	65mm	10	0,031	61053/060	61063/060
		0,5mm	4,21l	65mm	10	0,031	61053/062	61063/062
		0,5mm	6,41l	100mm	10	0,040	61053/100	61063/100
		0,5mm	6,41l	100mm	10	0,040	61053/102	61063/102
		0,6mm	9,51l	150mm	10	0,061	61053/150	61063/150
		0,6mm	9,51l	150mm	10	0,061	61053/152	61063/152
		0,7mm	11,27l	180mm	10	0,070	61053/180	61063/180
		0,7mm	11,27l	180mm	10	0,070	61053/182	61063/182

--0  
STAINLESS STEEL 304  
ACERO INOXIDABLE 304

--2  
STAINLESS STEEL 430  
ACERO INOXIDABLE 430

--3  
STAINLESS STEEL 201  
ACERO INOXIDABLE 201



	External measures Medidas externas Internal measures Medidas internas	Thickness Espesor	Cap.	Prof.	Un.	m³	Without handles Sin asas	With handles Con asas
	2/4 530 x 162mm 505 x 137mm	0,5mm	2,23l	40mm	10	0,014	61054/040	-
		0,5mm	2,23l	40mm	10	0,014	61054/042	-
		0,5mm	4,06l	65mm	10	0,037	61054/060	61064/060
		0,5mm	4,06l	65mm	10	0,037	61054/062	61064/062
		0,5mm	6,11l	100mm	10	0,054	61054/100	61064/100
		0,5mm	6,11l	100mm	10	0,054	61054/102	61064/102
		0,6mm	9,03l	150mm	10	0,070	61054/150	61064/150
		0,6mm	9,03l	150mm	10	0,070	61054/152	61064/152
	1/3 325 x 176mm 300 x 151mm	0,5mm	0,70l	20mm	20	0,009	61055/020	-
		0,5mm	0,70l	20mm	20	0,009	61055/022	-
		0,5mm	1,15l	40mm	20	0,024	61055/040	-
		0,5mm	1,15l	40mm	20	0,024	61055/042	-
		0,5mm	2,30l	65mm	10	0,023	61055/060	61065/060
		0,5mm	2,30l	65mm	10	0,023	61055/062	61065/062
		0,5mm	3,90l	100mm	10	0,030	61055/100	61065/100
		0,5mm	3,90l	100mm	10	0,030	61055/102	61065/102
		0,6mm	5,42l	150mm	10	0,048	61055/150	61065/150
		0,6mm	5,42l	150mm	10	0,045	61055/152	61065/152
	1/4 265 x 162mm 240 x 137mm	0,5mm	0,25l	20mm	20	0,007	61056/020	-
		0,5mm	0,25l	20mm	20	0,007	61056/022	-
		0,5mm	0,93l	40mm	20	0,007	61056/040	-
		0,5mm	0,93l	40mm	20	0,007	61056/042	-
		0,5mm	1,80l	65mm	10	0,023	61056/060	61066/060
		0,5mm	1,80l	65mm	10	0,023	61056/062	61066/062
		0,5mm	2,72l	100mm	10	0,024	61056/100	61066/100
		0,5mm	2,72l	100mm	10	0,024	61056/102	61066/102
	2/8 325 x 132mm 300 x 107mm	0,8mm	4,06l	150mm	10	0,025	61056/153*	-
		0,8mm	5,27l	200mm	10	0,022	61056/200*	61066/200*
		0,5mm	1,83l	65mm	10	0,023	61057/060	61067/060
		0,5mm	1,83l	65mm	10	0,023	61057/062	61067/062
		0,5mm	2,74l	100mm	10	0,031	61057/100	61067/100
		0,5mm	2,74l	100mm	10	0,031	61057/102	61067/102
	1/6 176 x 162mm 151 x 137mm	0,5mm	1,06l	65mm	20	0,023	61058/060	61068/060
		0,5mm	1,06l	65mm	20	0,023	61058/062	61068/062
		0,7mm	1,52l	100mm	20	0,040	61058/100	61068/100
		0,7mm	1,52l	100mm	20	0,040	61058/102	61068/102
		0,8mm	2,40l	150mm	20	0,033	61058/153*	-
	1/9 176 x 108mm 151 x 83mm	0,8mm	2,97l	200mm	20	0,044	61058/203*	-
		0,5mm	0,67l	65mm	20	0,023	61059/060	-
		0,5mm	0,67l	65mm	20	0,023	61059/062	-
		0,8mm	1,04l	100mm	20	0,035	61059/100	-
		0,8mm	1,04l	100mm	20	0,025	61059/103*	-

\* Imported Product / Producto Importado



GASTRONORM  
CUBA GASTRONÓMICA  
1/1

	Ref.	Un.	m <sup>3</sup>	7891116
65mm	61051/065	06	0,082	110447
100mm	61051/105	06	0,082	110454

6 units per display box / Caja display con 6 unidades



GASTRONORM  
CUBA GASTRONÓMICA  
1/3

	Ref.	Un.	m <sup>3</sup>	7891116
65mm	61055/065	06	0,020	110508
100mm	61055/105	06	0,020	110515

6 units per display box / Caja display con 6 unidades



GASTRONORM  
CUBA GASTRONÓMICA  
1/4

	Ref.	Un.	m <sup>3</sup>	7891116
65mm	61058/065*	10	0,017	110522
100mm	61058/105	06	0,017	110539

6 units per display box / Caja display con 6 unidades  
\*10 units per display box / Caja display con 10 unidades

# PERFORATED GASTRONORM CUBAS GASTRONÓMICAS PERFORADAS

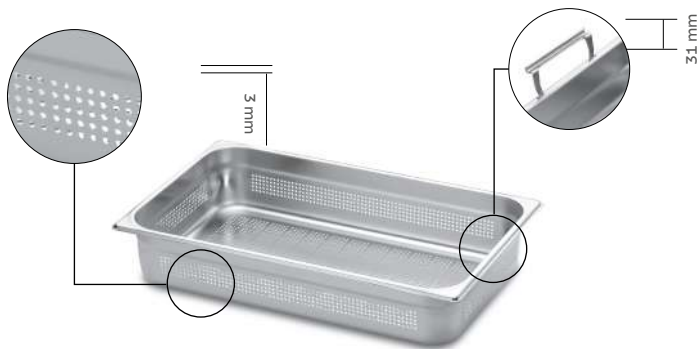

	External measures Medidas externas	Cap.	Prof.	Un.	m <sup>3</sup>	Without handles Sin asas
1/1	505x300mm	5,35l	40mm	10	0,070	61071/043*
	530x325mm	9,06l	65mm	10	0,071	61071/063*
		14,00l	100mm	10	0,070	61071/103*



	External measures Medidas externas	Cap.	Prof.	Un.	m <sup>3</sup>	Without handles Sin asas
2/3	329x300 mm 354x325 mm	3,40l	40 mm	20	0,070	61072/040*



# SERVING SERVIR



NO-SLIP SERVING TRAY  
BANDEJA PARA SERVIR ANTIDESLIZANTE

	Ref.	Un.	m <sup>3</sup>	7891116
Ø 40cm	61413/407	12	0,013	075869





SERVING TRAY  
BANDEJA PARA SERVIR

	Ref.	Un.	m <sup>3</sup>	7891116
Ø 30,2cm	61413/300*	12	0,007	006481
Ø 35,2cm	61413/350*	12	0,009	006498
Ø 40cm	61413/400*	12	0,013	006528
Ø 45cm	61413/450*	12	0,024	042953



SERVING TRAY  
BANDEJA PARA SERVIR

	Ref.	Un.	m <sup>3</sup>	7891116
Ø 35,2cm	61413/355	06	0,092	036839

6 units per display box / Caja display con 6 unidades



DISH COVER  
CAMPANA PARA PLATO

	Ref.	Un.	m <sup>3</sup>	7891116
Ø 28,2cm	61429/280*	10	0,021	044582



DISH COVER  
CAMPANA PARA PLATO

	Ref.	Un.	m <sup>3</sup>	7891116
Ø 24,5cm	61427/240*	10	0,026	008874



SELF SERVICE TRAY 6 DIVISIONS  
BANDEJA AUTO-SERVICIO 6 CAVIDADES

	Ref.	Un.	m <sup>3</sup>	7891116
397 x 296mm	61411/060	30	0,035	007860

# UTENSILS UTENSILIOS



SERVING SPOON  
CUCHARA PARA SERVIR

	Ref.	Un.	m <sup>3</sup>	7891116
525 x 82mm	63813/100	06	0,018	045190



SKIMMER  
ESPUMADERA

	Ref.	Un.	m <sup>3</sup>	7891116
560 x 162mm	63813/220	06	0,018	042328



SOUP LADLE  
CAZO PARA SOPA

	Ref.	Un.	m <sup>3</sup>	7891116
500 x 110mm - 290ml	63813/710	06	0,018	042342



CARVING TINE FORK  
TENEDOR

	Ref.	Un.	m <sup>3</sup>	7891116
500 x 25mm	63813/470	06	0,018	042335



SOUP LADLE  
CAZO PARA SOPA

	Ref.	Un.	m <sup>3</sup>	7891116
550 x 130mm - 480ml	63813/730	06	0,018	042359



SKIMMER  
ESPUMADERA

	Ref.	Un.	m <sup>3</sup>	7891116
530 x 130mm	63813/720	06	0,018	045350



# ACCESSORIES ACCESORIOS



Ø 21cm - 445 x 210mm

KITCHEN STRAINER  
COLADOR CHINOY

Ref.	Un.	m <sup>3</sup>	7891116
63850/210*	01	0,024	053621



APPETIZER SPOON  
CUCHARA DE APERITIVO

Ref.	Un.	m <sup>3</sup>	7891116
63965/690**	60	0,005	060131



APPETIZER SPOON  
CUCHARA DE APERITIVO

Ref.	Un.	m <sup>3</sup>	7891116
61618/000**	60	0,002	073780



NAPKIN RING  
ARO PARA SERVILLETA  
COSMOS

Ref.	Un.	m <sup>3</sup>	7891116
61217/060	24	0,006	028063

On the center: satin finish / on the edge: mirror finish  
En el medio pulido satinado y en los bordes pulido  
espejo



SOUSPLAT  
COSMOS

Ref.	Un.	m <sup>3</sup>	7891116
61210/300	10	0,030	005101
61210/301**	12	0,007	018965

# CHURRASCO ASADO

---



Exclusive material for legal entities/corporate clients.  
Material exclusivo para clientes persona jurídica.

## DESIGN AND DURABILITY

# COOKING AND SERVING

The resistance and convenience of stainless steel at the service of a tradition that has won over taste buds all over the world. More than just a cuisine, the Brazilian churrasco is now an artform that demands special care in preparation and convenience in serving. This is why Tramontina offers a complete line of flatware and utensils to highlight the flavors and aromas of all different types of meat. For those who enjoy doing beautifully well in good company.

## DISEÑO Y DURABILIDAD

# PARA ASAR Y SERVIR

La resistencia y la practicidad del acero inoxidable al servicio de una tradición que conquistó los paladares del mundo. Más que gastronomía, el asado hoy es una arte que exige cuidado en la preparación y practicidad al servir. Por eso, Tramontina ofrece una línea completa de cubiertos y utensilios que realzan los sabores y aromas de los más variados tipos de carne. Para los que les gusta lucirse en buena compañía.





# CUTLERY SETS

## JUEGO DE CUBIERTOS



STEAK KNIVES SET  
JUEGO DE CUCHILLOS PARA ASADO  
OSLO  
6 PC./PZAS.

Ref.	Un.	m <sup>3</sup>	7891116
66985/624	02	0,007	160602

Contents / Contenido:  
6 Steak Knives / Cuchillos para Asado



STEAK SET  
JUEGO PARA ASADO  
OSLO  
8 PC./PZAS.

Ref.	Un.	m <sup>3</sup>	7891116
66985/644	02	0,007	160619

Contents / Contenido:  
4 Steak Knives / Cuchillos para Asado  
4 Steak Forks / Tenedores para Asado



STEAK SET  
JUEGO PARA ASADO  
MÔNACO  
8 PC./PZAS.

Ref.	Un.	m <sup>3</sup>	7891116
66917/614	02	0,007	127896

Contents / Contenido:  
4 Steak knives / Cuchillos para Asado  
4 Steak Forks / Tenedores para Asado



**STEAK SET  
JUEGO PARA ASADO  
CLASSIC  
8 PC./PZAS.**

Ref.	Un.	m <sup>3</sup>	7891116
66928/614	02	0,007	097809

Contents / Contenido:  
4 Steak knives / Cuchillos para Asado  
4 Steak Forks / Tenedores para Asado



**STEAK KNIVES SET  
JUEGO DE CUCHILLOS PARA ASADO  
CLASSIC  
2 PC./PZAS.**

Ref.	Un.	m <sup>3</sup>	7891116
66928/656	02	0,004	119112

Contents / Contenido:  
2 Jumbo Steak Knives / Cuchillos para Asado Jumbo



**STEAK SET  
JUEGO PARA ASADO  
CLASSIC  
8 PC./PZAS.**

Ref.	Un.	m <sup>3</sup>	7891116
66928/617	01	0,007	116135

Contents / Contenido:  
4 Jumbo Steak Knives / Cuchillos para Asado Jumbo  
4 Steak Forks / Tenedores para Asado



STEAK SET  
 JUEGO PARA ASADO  
 CLASSIC  
 4 PC./PZAS.

Ref.	Un.	m <sup>3</sup>	7891116
66928/547	01	0,004	130711

Contents / Contenido:  
 2 Jumbo Steak Knives / Cuchillos para Asado Jumbo  
 2 Steak Forks / Tenedores para Asado



STEAK SET  
 JUEGO PARA ASADO  
 CLASSIC  
 8 PC./PZAS.

Ref.	Un.	m <sup>3</sup>	7891116
66928/567	01	0,007	130735

Contents / Contenido:  
 4 Jumbo Steak Knives / Cuchillos para Asado Jumbo  
 4 Steak Forks / Tenedores para Asado



STEAK SET  
 JUEGO PARA ASADO  
 CLASSIC  
 4 PC./PZAS.

Ref.	Un.	m <sup>3</sup>	7891116
66928/587	02	0,007	130759

Contents / Contenido:  
 2 Jumbo Steak Knives / Cuchillos para Asado Jumbo  
 2 Steak Forks / Tenedores para Asado



# JUMBO STEAK KNIVES

## CUCHILLOS PARA ASADO



JUMBO STEAK KNIFE WITH SERRATED  
EDGE  
CUCHILLO PARA ASADO JUMBO CON  
DIENTES

Ref.	Un.	m <sup>3</sup>	7891116
63928/780	24	0,005	095232



JUMBO STEAK KNIFE WITH SERRATED  
EDGE AND ENGRAVING  
CUCHILLO PARA ASADO JUMBO CON  
DIENTES Y GRABADO

Ref.	Un.	m <sup>3</sup>	7891116
63928/784	24	0,005	112540



TABLE FORK  
TENEDOR DE MESA

Ref.	Un.	m <sup>3</sup>	7891116
63928/023	60	0,005	130322



STEAK KNIFE  
CUCHILLO PARA ASADO

Ref.	Un.	m <sup>3</sup>	7891116
63928/983	60	0,007	137444

# CUTLERY SETS

## JUEGO DE CUBIERTOS



STEAK KNIVES SET  
JUEGO DE CUCHILLOS PARA ASADO  
6 PC./PZAS.  
CLASSIC

	Ref.	Un.	m <sup>2</sup>	7891116
Serrated Edge / Dientes	66928/625	02	0,013	112595
Serrated Edge and Engraving / Dientes y Grabado	66928/627	02	0,013	116166

Contents/ Contenido:  
6 Jumbo Steak knives / Cuchillos para Asado Jumbo



STEAK SET  
JUEGO PARA ASADO  
12 PC./PZAS.  
CLASSIC

	Ref.	Un.	m <sup>2</sup>	7891116
Serrated Edge / Dientes	66928/635	02	0,013	112588
Serrated Edge and Engraving / Dientes y Grabado	66928/637	02	0,013	116104

Contents/ Contenido:  
6 Jumbo Steak knives / Cuchillos para Asado  
6 Steak Forks / Tenedores para Asado



BARBECUE TONG  
PINZA PARA ASADO

	Ref.	Un.	m <sup>2</sup>	7891116
	63800/685	30	0,007	074534



# COOKING GRATES ASADERAS



POULTRY ROASTER  
ASADERA PARA POLLO

	Ref.	Un.	m <sup>3</sup>	7891116
380 x 320 x 84mm	61322/280	05	0,045	139301



MULTI-USE TRAY  
ASADERA MULTIUSO

	Ref.	Un.	m <sup>3</sup>	7891116
472 x 306 x 49mm	61321/410	04	0,053	139295



FISH TRAY  
ASADERA PARA PESCADO

	Ref.	Un.	m <sup>3</sup>	7891116
484 x 320 x 36mm	61320/410	05	0,015	139288



ROUND GRIDDLE PAN  
DISCO PARA GRILLAR

	Ref.	Un.	m <sup>3</sup>	7891116
545 x 440 x 60mm	62835/440	01	0,014	137642



# NUMERAL INDEX ÍNDICE NUMÉRICO

REF.	PÁG.	REF.	PÁG.	REF.	PÁG.	REF.	PÁG.
60900/000	61	61051/040	365	61056/200*	366	61067/060	366
60900/010	61	61051/042	365	61057/060	366	61067/062	366
60900/020	61	61051/060	365	61057/062	366	61067/100	366
60900/050	61	61051/062	365	61057/100	366	61067/102	366
61021/010	355	61051/065	367	61057/102	366	61068/060	366
61021/012*	355	61051/100	365	61058/060	366	61068/062	366
**61026/010	353	61051/102	365	61058/062	366	61068/100	366
*61026/020	354	61051/105	367	61058/065*	367	61068/102	366
**61026/023	354	61051/150	365	61058/100	366	61071/043*	368
**61027/010	353	61051/152	365	61058/102	366	61071/063*	368
*61027/020	353	61051/180	365	61058/105	367	61071/103*	368
**61027/023	353	61051/182	365	61058/153*	366	61072/040*	368
61030/810	361	61052/020	365	61058/203*	366	61093/110	362
61030/820	361	61052/022	365	61059/060	366	61093/115	363
61039/420	354	61052/040	365	61059/062	366	61093/120	362
61040/210	356	61052/042	365	61059/100	366	61093/130	362
61040/211*	356	61052/060	365	61059/103*	366	61093/135	363
61040/212*	356	61052/062	365	61060/060	365	61093/140	362
61040/217**	356	61052/100	365	61060/062	365	61093/160	362
61040/220	356	61052/102	365	61060/100	365	61093/165	364
61040/221*	356	61052/150	365	61060/102	365	61093/190	362
61040/222*	356	61052/152	365	61060/150	365	61093/210	362
61040/276	356	61052/180	365	61060/152	365	61093/230	362
61041/000	358	61052/182	365	61060/180	365	61093/240	362
61041/120	361	61053/020	365	61060/182	365	61093/280	362
61041/200	358	61053/022	365	61061/060	365	61094/110	362
61041/211*	358	61053/040	365	61061/062	365	61094/120	362
61041/212*	358	61053/042	365	61061/100	365	61094/130	362
61041/810	361	61053/060	365	61061/102	365	61094/140	362
61041/820	361	61053/062	365	61061/150	365	61094/160	362
61042/000	359	61053/100	365	61061/152	365	61094/210	362
61042/120	361	61053/102	365	61061/180	365	61094/230	362
61042/200	358	61053/150	365	61061/182	365	61094/240	362
61042/211*	358	61053/152	365	61062/060	365	61094/280	362
61042/212*	358	61053/180	365	61062/062	365	61095/110	362
61043/010	355	61053/182	365	61062/100	365	61095/120	362
61043/012*	355	61054/040	366	61062/102	365	61095/130	362
61043/017**	355	61054/042	366	61062/150	365	61095/140	362
61043/020	355	61054/060	366	61062/152	365	61095/160	362
61043/022*	355	61054/062	366	61062/180	365	61095/210	362
61043/027**	355	61054/100	366	61062/182	365	61095/230	362
61045/010	356	61054/102	366	61063/060	365	61095/240	362
61045/012*	356	61054/150	366	61063/062	365	61095/280	362
61045/017**	356	61054/152	366	61063/100	365	61096/110	363
61045/020	356	61055/020	366	61063/102	365	61096/120	363
61045/022*	356	61055/022	366	61063/150	365	61096/130	363
61045/210	358	61055/040	366	61063/152	365	61096/140	363
61047/010	355	61055/042	366	61063/180	365	61096/160	363
61047/012*	355	61055/060	366	61063/182	365	61096/210	363
61047/020	355	61055/062	366	61064/060	366	61096/230	363
61047/022*	355	61055/065	367	61064/062	366	61096/240	363
61048/076	356	61055/100	366	61064/100	366	61096/280	363
61050/020	365	61055/102	366	61064/102	366	61101/010*	33
61050/022	365	61055/105	367	61064/150	366	61101/020*	33
61050/040	365	61055/150	366	61064/152	366	61101/030*	33
61050/042	365	61055/152	366	61065/060	366	61101/040*	34
61050/060	365	61055/203*	366	61065/062	366	61101/050*	32
61050/062	365	61056/020	366	61065/100	366	61101/100	294
61050/100	365	61056/022	366	61065/102	366	61101/210*	34
61050/102	365	61056/040	366	61065/150	366	61101/220*	34
61050/150	365	61056/042	366	61065/152	366	61101/230*	34
61050/152	365	61056/060	366	61066/060	366	61102/000	311
61050/180	365	61056/062	366	61066/062	366	61102/007	239
61050/182	365	61056/100	366	61066/100	366	61105/000	42
61051/020	365	61056/102	366	61066/102	366	61105/002	43
61051/022	365	61056/153*	366	61066/200*	366	61105/005	42

REF.	PÁG.	REF.	PÁG.	REF.	PÁG.	REF.	PÁG.
61105/007	239	61227/143	16	61347/110*	313	61570/100	301
61106/000*	326	61227/144	16	61347/200*	311	61575/120	301
61107/140	45	61227/160	15	61347/210*	315	61575/140	301
61114/320	267	61227/162	16	61347/220*	315	61580/090	301
61119/000	40	61227/163	16	61347/300*	315	61581/090	301
61119/042	43	61227/164	16	61400/200*	259	61618/000**	372
61119/045	42	61227/180	15	61400/250*	259	61636/101	277
61119/049	41	61227/182	16	61402/200*	259	61636/103	277
61119/059	41	61227/183	16	61402/260*	259	61636/104	277
61119/100*	38	61227/184	16	61409/340	154	61636/106	277
61119/110*	38	61228/160	14	61409/380	154	61636/107	277
61120/000	41	61228/161*	14	61410/240	265	61636/108	277
61120/002	43	61228/200	14	61410/241*	265	61636/930	280
61120/005	42	61228/201*	14	61411/060	370	61637/103	280
61130/050	41	61228/240	14	61412/400*	257	61637/106	280
61131/050	41	61228/241*	14	61413/300*	370	61637/107	280
61134/080	41	61228/280	14	61413/350*	370	61637/108	280
61144/120	44	61228/281*	14	61413/355	370	61637/503	280
61210/300	372	61228/321*	14	61413/400*	370	61637/506	280
61210/301**	372	61229/000	18	61413/407	369	61637/507	280
61216/120	44	61229/005	18	61413/450*	370	61638/070	283
61216/126	45	61229/030*	21	61414/360	327	61638/100	283
61216/127	239	61229/035*	21	61415/360	327	61640/370	280
61217/060	372	61229/040*	21	61416/231*	263	61640/400	280
61218/180	326	61229/045*	21	61417/071*	350	61641/120	281
61218/181*	326	61229/080	9	61421/090*	267	61641/123	281
61219/081*	324	61229/085	19	61422/201*	138	61641/180	281
61219/101*	324	61229/087	19	61422/250	138	61641/900	281
61219/120	324	61229/160	9	61422/251*	138	61641/910	281
61219/121*	324	61229/190	9	61424/000	264	61642/140	281
61219/140	324	61229/230	9	61426/170	330	61642/200	281
61219/141*	324	61229/560	9	61427/240*	370	61643/063*	285
61220/091*	11	61229/565	19	61429/280*	370	61643/065*	285
61220/141*	11	61229/567	19	61437/080	302	61644/030	282
61220/181*	11	61251/075	350	61437/081*	302	61644/034	282
61220/201*	11	61254/235	350	61440/350	257	61644/036	282
61220/221*	11	61257/230	344	61440/420	257	61644/050	282
61220/251*	11	61257/235	340	61440/490	257	61644/054	282
61220/281*	11	61273/000	264	61470/070	301	61644/056	282
61221/164	8	61276/420	327	61470/080	301	61644/070	282
61221/165	8	61284/120	44	61470/100	301	61644/074	282
61221/167	8	61310/301*	152	61470/110	301	61644/076	282
61221/194	8	61310/341*	152	61473/080	264	61644/100	283
61221/195	8	61310/391*	152	61475/120	302	61644/104	283
61221/197	8	61310/431*	152	61475/140	302	61644/106	283
61221/234	8	61310/481*	152	61482/150	307	61644/900	283
61221/235	8	61310/521*	152	61482/183	307	61644/901	283
61221/237	8	61315/344	152	61483/013	306	61645/030	282
61222/090	9	61315/394	152	61483/023	306	61645/033	282
61222/140	9	61315/434	152	61485/160	306	61645/034	282
61222/180	9	61316/390	257	61488/213*	307	61645/036	282
61222/200	9	61318/200	326	61517/454	261	61645/050	282
61222/220	9	61318/201*	326	61519/000	264	61645/053	282
61222/250	9	61319/140	324	61522/000	44	61645/054	282
61222/280	9	61320/410	380	61525/454	261	61645/056	282
61224/241*	13	61321/410	380	61528/304	261	61645/070	282
61224/281*	13	61322/280	380	61528/394	261	61645/073	282
61224/321*	13	61338/360	330	61529/420	257	61645/074	282
61224/361*	13	61339/112*	267	61530/000	31	61645/076	282
61225/040*	24	61339/113*	267	61530/010	31	61645/100	283
61225/080*	24	61340/200	326	61530/100	31	61645/103	283
61225/120*	24	61343/000	326	61531/000	303	61645/104	283
61227/010*	22	61344/000*	323	61532/000	44	61645/106	283
61227/020*	22	61345/000*	323	61533/010	40	61645/900	283
61227/030*	22	61346/080	317	61535/030	30	61645/910	283
61227/040*	22	61346/100*	317	61535/530	29	61645/920	283
61227/050*	23	61346/200*	317	61535/730	30	61645/930	283
61227/120	15	61347/000*	311	61536/000*	29	61646/086*	286
61227/122	16	61347/010*	315	61537/000*	28	61648/040*	342
61227/140	15	61347/050*	313	61560/530	255	61648/045*	338
61227/142	16	61347/100*	311	61570/080	301	61648/440*	18

REF.	PÁG.	REF.	PÁG.	REF.	PÁG.	REF.	PÁG.
61648/445*	18	62144/220	72	62483/160	84	62635/024	96
61649/030*	342	62144/240	71	62483/200	84	62635/034	96
61649/035*	338	62144/260	72	62483/240	84	62635/200	96
61652/000*	37	62145/240	71	62484/160	84	62635/206	96
61653/000*	37	62155/200	72	62484/200	84	62635/207	96
61653/100*	35	62155/207	74	62484/240	84	62635/260	96
61654/100*	35	62155/260	72	62485/200	84	62635/266	96
61655/000*	37	62155/267	74	62485/240	84	62635/267	96
61700/200*	260	62155/300	72	62487/160	86	62635/300	96
61700/250*	260	62155/307	74	62490/160	86	62635/304	96
61700/255	260	62158/320	71	62490/200	86	62635/306	96
61700/300*	260	62158/327	72	62492/140	86	62635/307	96
61700/400*	260	62159/220	72	62500/200	99	62636/261	93
61700/500*	260	62159/227	72	62500/240	99	62637/306	96
61702/200*	259	62159/280	72	62500/280	99	62639/360	94
61702/260*	259	62159/287	72	62501/140	99	62643/400*	93
61702/265	260	62161/160	77	62501/160	99	62643/450*	93
61702/300*	259	62161/200	77	62501/200	99	62644/360*	93
61703/501*	261	62163/240	77	62501/240	99	62645/400*	94
61703/601*	261	62164/200	77	62503/160	99	62645/500*	94
61712/480	257	62164/240	77	62503/200	99	62646/360*	94
61712/481*	257	62165/240	77	62503/240	99	62648/200	93
61731/300	156	62175/200	78	62503/280	99	62648/240	93
61731/350	156	62175/207	78	62504/160	99	62648/280	93
61731/355	156	62175/260	78	62504/200	99	62649/400*	94
61731/400	156	62175/267	78	62504/240	99	62649/450*	94
61744/300	156	62175/300	78	62504/280	99	62649/500*	94
61760/000*	290	62175/307	78	62505/200	100	62650/200	136
61760/476	303	62195/205	128	62505/240	100	62651/160	136
61762/090*	295	62195/207	128	62505/280	100	62651/164	136
61763/060*	295	62195/245	128	62507/140	100	62651/168	136
61764/060*	290	62195/247	128	62507/160	100	62651/200	136
61764/100*	295	62281/160	122	62508/200	100	62651/204	136
61767/560*	289	62283/160	122	62508/240	100	62653/220	136
61767/600*	289	62283/200	122	62508/280	100	62653/224	136
61768/010*	289	62283/240	122	62510/160	101	62653/228	136
61768/020*	289	62284/160	122	62510/200	101	62653/240	136
61768/100*	290	62284/200	122	62510/240	101	62653/244	136
61768/500*	292	62284/240	122	62511/223	150	62653/248	136
61768/510*	292	62285/160	122	62512/145	100	62654/160	136
61769/000*	292	62285/200	122	62513/222	150	62654/164	136
61769/010*	292	62285/240	122	62513/223*	150	62654/168	136
61781/120	45	62295/240	122	62513/226	150	62654/180	136
61781/250	255	62376/200	144	62514/240	101	62654/184	136
61781/390	255	62376/204	144	62516/222	150	62654/188	136
61781/510	255	62376/207	144	62516/223*	150	62654/200	136
61782/110	44	62376/240	144	62516/226	150	62654/204	136
61787/000	264	62376/244	144	62517/240	101	62654/208	136
62121/163	113	62376/247	144	62517/241*	101	62654/220	136
62123/203	113	62378/340	144	62620/991	94	62654/224	136
62123/300	118	62378/348	144	62621/140	89	62654/228	136
62124/163	113	62401/160	133	62621/160	89	62654/240	136
62124/203	113	62401/200	133	62621/200	89	62654/244	136
62124/243	113	62403/160	133	62621/240	89	62654/248	136
62125/203	113	62403/200	133	62623/160	89	62655/180	138
62125/280	118	62403/240	133	62623/200	89	62655/184	138
62125/300	118	62404/160	133	62623/240	89	62655/188	138
62132/146	111	62404/200	133	62623/280	89	62655/200	138
62135/200	117	62404/240	133	62624/160	89	62655/204	138
62135/207	117	62405/160	133	62624/200	89	62655/208	138
62135/240	117	62405/200	133	62624/240	89	62655/220	138
62135/247	117	62405/240	133	62624/280	89	62655/224	138
62137/240	118	62410/200	134	62625/200	89	62655/228	138
62138/280	117	62415/240	133	62625/240	89	62655/240	138
62138/282	117	62416/200	146	62625/280	89	62655/244	138
62138/288	117	62416/220	146	62627/160	89	62655/248	138
62140/300	72	62417/240	134	62630/160	90	62657/160	138
62141/160	71	62480/200	84	62630/200	90	62657/164	138
62141/200	71	62480/240	84	62630/240	90	62657/168	138
62143/240	71	62481/160	84	62634/200	90	62660/200	138
62144/200	71	62481/200	84	62635/014	96	62664/120	139



REF.	PÁG.	REF.	PÁG.	REF.	PÁG.	REF.	PÁG.
62664/121*	139	63809/510*	55	63902/100	204	63906/072	251
62666/200	143	63809/520*	56	63902/101	246	63906/080	202
62666/240	143	63809/530*	56	63902/110	204	63906/082	251
62667/203	138	63809/540*	56	63902/120	204	63906/090	202
62667/223	138	63809/550*	56	63902/140	204	63906/091	246
62676/220*	148	63809/560*	55	63902/150	204	63906/100	202
62713/394	261	63809/590*	56	63902/151	246	63906/101	246
62718/294	152	63809/610*	315	63902/180	204	63906/110	202
62718/334	152	63809/760*	313	63902/182	251	63906/120	202
62718/374	152	63809/770*	315	63902/190	204	63906/125	246
62720/200	107	63809/900*	52	63902/191	246	63906/140	202
62720/240	107	63809/910*	52	63902/200	204	63906/150	202
62721/200	107	63809/920*	52	63902/210	204	63906/151	246
62721/240	107	63812/091	51	63902/211	246	63906/161	246
62723/200	107	63812/092	51	63902/220	204	63906/180	202
62723/240	107	63812/101	51	63902/221	246	63906/182	251
62723/280	107	63812/102	51	63902/300	204	63906/190	202
62724/160	107	63812/221	51	63902/740	204	63906/191	246
62724/200	107	63812/222	51	63902/750	204	63906/200	202
62724/240	107	63812/321	50	63903/010	200	63906/210	202
62724/280	107	63812/322	50	63903/020	200	63906/211	246
62725/200	107	63812/391	51	63903/030	200	63906/220	202
62725/240	107	63812/392	51	63903/040	200	63906/221	246
62725/280	107	63812/471	51	63903/050	200	63906/240	202
62727/160	107	63812/472	51	63903/060	200	63906/300	202
62730/200	108	63812/491	51	63903/070	200	63906/401	246
62835/440	380	63812/492	51	63903/080	200	63906/470	202
62932/140	139	63812/501	51	63903/100	200	63906/471	246
62934/120	139	63812/502	51	63903/101	246	63906/840	202
63800/602	46	63813/100	371	63903/120	200	63906/890	202
63800/604	49	63813/220	371	63903/125	246	63912/010	188
63800/605	46	63813/470	371	63903/140	200	63912/020	188
63800/607	238	63813/710	371	63903/150	200	63912/040	188
63800/612	46	63813/720	371	63903/151	246	63912/050	188
63800/615	46	63813/730	371	63903/180	200	63912/070	188
63800/622	46	63814/090	50	63903/190	200	63912/080	188
63800/624	49	63814/100	50	63903/191	246	63912/090	188
63800/625	46	63814/470	50	63903/200	200	63912/100	188
63800/627	238	63815/091	58	63903/240	200	63912/110	188
63800/632	47	63815/092	58	63903/300	200	63912/120	188
63800/635	47	63815/101	58	63903/470	200	63912/140	188
63800/642	46	63815/102	58	63903/471	246	63912/150	188
63800/645	46	63815/221	58	63905/010	208	63912/190	188
63800/647	238	63815/222	58	63905/012	251	63912/210	188
63800/650	47	63815/321	58	63905/020	208	63912/240	188
63800/652	47	63815/322	58	63905/022	251	63912/250	188
63800/682	47	63815/391	58	63905/030	208	63912/260	188
63800/684	47	63815/392	58	63905/032	251	63912/290	188
63800/685	379	63815/471	58	63905/070	208	63912/830	188
63800/687	238	63815/472	58	63905/072	251	63912/860	188
63800/700	48	63815/501	58	63905/080	208	63912/980	188
63800/702	48	63815/502	58	63905/082	251	63915/010	174
63800/802	48	63850/210**	372	63905/140	208	63915/020	174
63800/805	48	63902/010	204	63905/142	251	63915/040	174
63800/842	48	63902/012	251	63905/180	208	63915/050	174
63800/845	48	63902/022	251	63905/182	251	63915/070	174
63800/847	238	63902/027	204	63905/300	208	63915/080	174
63800/862	48	63902/030	204	63905/302	251	63915/090	174
63800/865	48	63902/032	251	63906/010	202	63915/100	174
63809/090*	55	63902/040	204	63906/012	251	63915/110	174
63809/100*	55	63902/042	251	63906/020	202	63915/120	174
63809/130*	52	63902/050	204	63906/022	251	63915/140	174
63809/150*	55	63902/052	251	63906/030	202	63915/150	174
63809/220*	55	63902/060	204	63906/032	251	63915/170	174
63809/230*	55	63902/062	251	63906/040	202	63915/190	174
63809/400*	56	63902/070	204	63906/042	251	63915/210	174
63809/410*	52	63902/072	251	63906/050	202	63915/240	174
63809/420*	52	63902/080	204	63906/052	251	63915/250	174
63809/440*	52	63902/082	251	63906/060	202	63915/260	174
63809/490*	56	63902/090	204	63906/062	251	63915/280	174
63809/500*	55	63902/091	246	63906/070	202	63915/290	174

REF.	PÁG.	REF.	PÁG.	REF.	PÁG.	REF.	PÁG.
63915/810	174	63925/250	172	63932/150	178	63945/072	251
63915/837	174	63925/260	172	63932/190	178	63945/080	206
63915/987	174	63925/270	172	63932/210	178	63945/082	251
63917/010	176	63925/280	172	63932/250	178	63945/100	206
63917/020	176	63925/290	172	63932/260	178	63945/101	246
63917/040	176	63925/830	172	63932/270	178	63945/120	206
63917/050	176	63925/860	172	63932/280	178	63945/125	246
63917/070	176	63925/980	172	63932/290	178	63945/140	206
63917/080	176	63928/010	168	63932/810	178	63945/150	206
63917/090	176	63928/020	168	63932/830	178	63945/151	246
63917/100	176	63928/023	378	63932/837	178	63945/180	206
63917/110	176	63928/040	168	63932/860	178	63945/182	251
63917/120	176	63928/050	168	63932/867	178	63945/190	206
63917/140	176	63928/070	168	63932/980	178	63945/191	246
63917/150	176	63928/080	168	63932/987	178	63945/470	206
63917/170	176	63928/090	168	63934/010	180	63945/471	246
63917/190	176	63928/100	168	63934/020	180	63950/012	251
63917/200	176	63928/110	168	63934/040	180	63950/017	198
63917/210	176	63928/120	168	63934/050	180	63950/022	251
63917/240	176	63928/140	168	63934/070	180	63950/027	198
63917/250	176	63928/150	168	63934/080	180	63950/032	251
63917/260	176	63928/170	168	63934/090	180	63950/037	198
63917/270	176	63928/190	168	63934/100	180	63950/042	251
63917/280	176	63928/210	168	63934/110	180	63950/047	198
63917/290	176	63928/240	168	63934/120	180	63950/052	251
63917/830	176	63928/250	168	63934/140	180	63950/057	198
63917/837	176	63928/260	168	63934/150	180	63950/062	251
63917/860	176	63928/270	168	63934/210	180	63950/067	198
63917/867	176	63928/280	168	63934/250	180	63950/072	251
63917/980	176	63928/290	168	63934/260	180	63950/077	198
63917/987	176	63928/780	378	63934/837	180	63950/082	251
63924/010	170	63928/784	378	63934/867	180	63950/087	198
63924/020	170	63928/810	168	63934/987	180	63950/090	198
63924/040	170	63928/830	168	63939/200	320	63950/091	241
63924/050	170	63928/850	168	63939/520	320	63950/100	198
63924/070	170	63928/860	168	63940/017	196	63950/101	241
63924/080	170	63928/980	168	63940/027	196	63950/110	198
63924/090	170	63928/983	378	63940/037	196	63950/120	198
63924/100	170	63929/010	166	63940/047	196	63950/140	198
63924/110	170	63929/020	166	63940/057	196	63950/150	198
63924/120	170	63929/030	166	63940/067	196	63950/151	241
63924/140	170	63929/040	166	63940/077	196	63950/182	251
63924/150	170	63929/050	166	63940/087	196	63950/187	198
63924/190	170	63929/060	166	63940/090	196	63950/190	198
63924/210	170	63929/070	166	63940/091	241	63950/191	241
63924/240	170	63929/080	166	63940/100	196	63950/200	198
63924/250	170	63929/090	166	63940/101	241	63950/210	198
63924/260	170	63929/100	166	63940/110	196	63950/211	241
63924/270	170	63929/110	166	63940/120	196	63950/240	198
63924/280	170	63929/120	166	63940/140	196	63950/242	251
63924/290	170	63929/140	166	63940/150	196	63950/250	198
63924/810	170	63929/150	166	63940/151	241	63950/260	198
63924/830	170	63929/180	166	63940/187	196	63950/270	198
63924/860	170	63929/210	166	63940/190	196	63950/290	198
63924/980	170	63929/240	166	63940/191	241	63950/470	198
63925/010	172	63929/250	166	63940/210	196	63950/471	241
63925/020	172	63929/260	166	63940/211	241	63950/510	48
63925/040	172	63929/270	166	63940/240	196	63950/840	198
63925/050	172	63929/280	166	63940/250	196	63950/890	198
63925/060	172	63929/810	166	63940/260	196	63960/010	194
63925/070	172	63932/010	178	63940/270	196	63960/020	194
63925/080	172	63932/020	178	63940/290	196	63960/030	194
63925/090	172	63932/040	178	63945/010	206	63960/040	194
63925/100	172	63932/050	178	63945/012	251	63960/050	194
63925/110	172	63932/070	178	63945/020	206	63960/060	194
63925/120	172	63932/080	178	63945/022	251	63960/070	194
63925/140	172	63932/090	178	63945/030	206	63960/077	232
63925/150	172	63932/100	178	63945/032	251	63960/080	194
63925/190	172	63932/110	178	63945/040	206	63960/090	194
63925/210	172	63932/120	178	63945/042	251	63960/091	241
63925/240	172	63932/140	178	63945/070	206	63960/097	237

REF.	PÁG.	REF.	PÁG.	REF.	PÁG.	REF.	PÁG.
63960/100	194	63965/110	190	63999/450*	319	64600/145*	334
63960/101	241	63965/120	190	63999/500*	319	64600/150*	321
63960/107	236	63965/140	190	63999/524	320	64600/160*	321
63960/110	194	63965/150	190	63999/525	320	64650/000*	35
63960/117	233	63965/180	190	64039/420	354	64760/400*	300
63960/120	194	63965/190	190	64210/900	330	64760/410*	300
63960/125	241	63965/210	190	64210/930**	324	64760/420*	300
63960/127	237	63965/250	190	64220/010	12	64760/500	297
63960/140	194	63965/260	190	64220/130	12	64760/600	297
63960/147	232	63965/270	190	64220/150	11	64780/500	304
63960/150	194	63965/290	190	64220/160	11	64780/610	265
63960/151	241	63965/690**	372	64220/180	11	64780/680	265
63960/157	233	63965/830	190	64220/190	11	65120/026	111
63960/161	241	63965/860	190	64220/210	12	65120/030	114
63960/163	237	63970/015	350	64220/220	13	65120/040	114
63960/188	194	63970/025	350	64220/620	15	65120/100	118
63960/200	194	63970/035	350	64220/630	15	65140/000	75
63960/210	194	63982/010	184	64220/710	14	65140/306	74
63960/211	241	63982/020	184	64220/750*	24	65140/307	75
63960/217	237	63982/030	184	64220/920	9	65140/316	74
63960/240	194	63982/040	184	64220/932	8	65140/317	75
63960/247	233	63982/050	184	64220/942	8	65140/326	74
63960/250	194	63982/060	184	64250/610	343	65140/327	75
63960/260	194	63982/070	184	64250/615	338	65140/336	74
63960/280	194	63982/080	184	64250/620	345	65140/337	75
63960/280	194	63982/090	184	64250/630	345	65160/000	78
63960/287	234	63982/100	184	64250/635	341	65180/310	128
63960/520	231	63982/110	184	64250/640	345	65180/510	128
63960/525	320	63982/120	184	64250/645	341	65240/200	81
63960/740	194	63982/140	184	64250/650	345	65280/300	123
63960/810	194	63982/150	184	64250/655	341	65280/310	123
63960/840	194	63982/180	184	64250/660	344	65280/312	125
63960/890	194	63982/250	184	64250/755	350	65280/313	125
63962/010	192	63982/260	184	64310/080	155	65300/310	130
63962/012*	251	63982/810	184	64310/114	154	65400/300	134
63962/020	192	63985/010	186	64310/150	154	65400/310	134
63962/022	251	63985/020	186	64310/250	154	65400/400	134
63962/030	192	63985/030	186	64310/260	155	65400/410	134
63962/032*	251	63985/040	186	64310/400	152	65480/010	87
63962/040	192	63985/050	186	64400/300	263	65480/036	87
63962/042	251	63985/060	186	64400/500	304	65480/086	87
63962/050	192	63985/070	186	64400/510	263	65480/400	86
63962/052	251	63985/080	186	64400/520	263	65500/000	104
63962/060	192	63985/090	186	64400/521*	263	65500/040	104
63962/062	251	63985/100	186	64430/780	297	65500/120	103
63962/070	192	63985/110	186	64430/790	297	65500/130	103
63962/072	251	63985/120	186	64430/800	297	65500/300	101
63962/080	192	63985/140	186	64430/810	297	65500/400	103
63962/082	251	63985/150	186	64430/820	299	65500/410	103
63962/090	192	63985/180	186	64470/500	304	65500/670	359
63962/100	192	63985/280	186	64470/510	304	65500/680	359
63962/110	192	63986/010	182	64510/080	266	65510/200	105
63962/120	192	63986/020	182	64510/090	266	65510/740	103
63962/140	192	63986/030	182	64510/184	269	65510/760	104
63962/150	192	63986/040	182	64510/190	266	*65510/770	105
63962/180	192	63986/050	182	64510/264	269	*65510/830	105
63962/182*	251	63986/060	182	64510/274	269	65620/010	91
63962/210	192	63986/070	182	64510/610	265	65620/186	91
63962/240	192	63986/080	182	64510/620	267	65620/216	90
63962/250	192	63986/090	182	64510/670	266	65620/400	90
63962/260	192	63986/100	182	64510/860	271	65620/410	90
63965/010	190	63986/110	182	64510/880	271	65620/411	95
63965/020	190	63986/120	182	64510/890	271	65650/050**	139
63965/030	190	63986/140	182	64550/210	262	65650/060**	141
63965/040	190	63986/150	182	64570/500	304	65650/070**	141
63965/050	190	63986/180	182	64580/500	304	*65650/324	142
63965/060	190	63986/230	294	64580/890	305	**65650/326	142
63965/070	190	63986/250	182	64600/130*	323	65650/680	359
63965/080	190	63986/260	182	64600/133*	321	65650/684	359
63965/090	190	63989/830	210	64600/140*	323	65660/164**	143
63965/100	190	63999/300*	319	64600/144*	334	65660/484*	141



REF.	PÁG.	REF.	PÁG.	REF.	PÁG.	REF.	PÁG.
*65660/694	142	66903/016	247	66906/005	250	66917/124*	222
*65660/714	142	66903/021	245	66906/010	224	66917/130	221
*65660/794	143	66903/025	246	66906/011	245	66917/134*	221
65720/000	109	66903/026	247	66906/014*	249	66917/140	221
65720/010	109	66903/031	245	66906/015	246	66917/144*	221
65720/410	108	66903/035	246	66906/016	247	66917/150	220
65720/740	109	66903/036	248	66906/021	245	66917/157*	220
65720/770	109	66903/041	245	66906/025	246	66917/160	222
66800/103	60	66903/045	246	66906/026	247	66917/207	218
66800/110*	49	66903/051	245	66906/031	245	66917/217	219
66812/700	59	66903/055	246	66906/035	246	66917/227	219
66815/700	59	66903/061	245	66906/036	248	66917/307	218
66815/710	59	66903/065	246	66906/041	245	66917/614	375
66815/730	59	66903/071	245	66906/045	246	66924/003	217
66902/000	224	66903/075	246	66906/051	245	66924/203	215
66902/004*	250	66903/076	247	66906/055	246	66924/215	216
66902/005	250	66903/081	245	66906/061	245	66924/223	216
66902/010	249	66903/085	246	66906/065	246	66924/305	215
66902/011	245	66903/121	245	66906/071	245	66925/003	217
66902/014*	249	66903/140	226	66906/075	246	66925/203	215
66902/015	246	66903/141	245	66906/076	247	66925/215	216
66902/016	247	66903/144*	226	66906/081	245	66925/223	216
66902/021	245	66903/145	246	66906/085	246	66925/305	215
66902/025	246	66903/150	226	66906/111	245	66928/003	217
66902/026	247	66903/154*	226	66906/115	246	66928/203	215
66902/031	245	66903/181	245	66906/121	245	66928/215	216
66902/035	246	66903/185	246	66906/141	245	66928/223	216
66902/036	248	66903/186*	248	66906/145	246	66928/300	215
66902/041	245	66903/201	245	66906/181	245	66928/547	377
66902/045	246	66903/205	246	66906/185	246	66928/567	377
66902/046	247	66903/206	248	66906/186*	248	66928/587	377
66902/051	245	66903/241	245	66906/201	245	66928/614	376
66902/055	246	66903/245	246	66906/205	246	66928/617	376
66902/061	245	66903/301	245	66906/206	248	66928/625	379
66902/065	246	66903/305	246	66906/241	245	66928/627	379
66902/071	245	66903/550	249	66906/300	220	66928/635	379
66902/075	246	66903/554*	249	66906/301	245	66928/637	379
66902/076	247	66903/606	247	66906/305	246	66928/656	376
66902/081	245	66903/650	249	66906/505	246	66929/000	217
66902/085	246	66903/654*	249	66906/550	249	66929/213	216
66902/111	245	66903/694	227	66906/554*	249	66929/225	216
66902/115	246	66903/830	250	66906/563	245	66929/232	214
66902/121	245	66903/834*	250	66906/606	247	66929/242	214
66902/141	245	66903/846*	248	66906/610	224	66929/300	215
66902/145	246	66903/976	248	66906/630	224	66929/352	214
66902/181	245	66905/011	245	66906/650	249	66932/005	217
66902/185	246	66905/015	246	66906/655*	249	66932/007	217
66902/186*	248	66905/021	245	66906/680	156	66932/120	222
66902/201	245	66905/025	246	66906/720	60	66932/124*	222
66902/205	246	66905/031	245	66906/730	303	66932/130	221
66902/206	248	66905/035	246	66906/770	225	66932/134*	221
66902/300	220	66905/071	245	66906/774*	225	66932/140	221
66902/301	245	66905/075	246	66906/780	226	66932/144*	221
66902/305	246	66905/080	223	66906/784*	226	66932/150	220
66902/550	249	66905/081	245	66906/790	225	66932/157*	220
66902/554*	249	66905/084*	223	66906/794*	225	66932/160	222
66902/606	247	66905/085	246	66906/830	250	66932/207	218
66902/610	224	66905/090	223	66906/834*	250	66932/217	219
66902/650	249	66905/094*	223	66906/840*	224	66932/227	219
66902/654*	249	66905/130	223	66906/846*	248	66932/307	218
66902/830	250	66905/141	245	66906/890	228	66934/005	217
66902/834*	250	66905/145	246	66906/976	248	66934/120	222
66902/840*	224	66905/150	224	66912/000	217	66934/124*	222
66902/846*	248	66905/181	245	66912/204	218	66934/130	221
66902/976	248	66905/185	246	66912/214	219	66934/134*	221
66903/004*	250	66905/301	245	66912/304	218	66934/140	221
66903/005	250	66905/305	246	66915/000	217	66934/144*	221
66903/010	249	66905/550	223	66915/304	218	66934/150	220
66903/011	245	66905/554*	223	66917/007	217	66934/154*	220
66903/014*	249	66906/000	249	66917/030	217	66934/160	222
66903/015	246	66906/004*	250	66917/120	222	66934/204	218

REF.	PÁG.	REF.	PÁG.	REF.	PÁG.	REF.	PÁG.
66934/214	219	66950/017	224	66960/300	220	66985/160	222
66934/304	218	66950/021	240	66960/505	241	66985/185	242
66934/593	236	66950/025	241	66960/510	232	66985/204	218
66934/610	222	66950/027	228	66960/533	234	66985/214	219
66940/007	224	66950/031	240	66960/543	234	66985/304	218
66940/011	240	66950/035	241	66960/550	243	66985/550	243
66940/015	241	66950/041	240	66960/554*	243	66985/554*	243
66940/021	240	66950/045	241	66960/573	234	66985/624	375
66940/025	241	66950/051	240	66960/583	233	66985/644	375
66940/027	228	66950/055	241	66960/607	233	66986/000	217
66940/031	240	66950/061	240	66960/740	236	66986/204	218
66940/035	241	66950/065	241	66960/760	243	66986/214	219
66940/041	240	66950/071	240	66960/810	232	66986/304	218
66940/051	240	66950/075	241	66960/840*	244	66999/510	303
66940/061	240	66950/081	240	66960/846*	243	66999/513	232
66940/071	240	66950/085	241	66960/917	234	66999/600	48
66940/075	241	66950/111	240	66960/976	243	66999/607	237
66940/081	240	66950/121	240	66962/005	217	639797/010	164
66940/085	241	66950/141	240	66962/120	222	639797/020	164
66940/111	240	66950/145	241	66962/124*	222	639797/040	164
66940/121	240	66950/181	240	66962/130	221	639797/050	164
66940/141	240	66950/185	241	66962/134*	221	639797/070	164
66940/181	240	66950/307	220	66962/140	221	639797/080	164
66940/185	241	66950/520	227	66962/144*	221	639797/090	164
66940/307	220	66950/637	224	66962/150	220	639797/100	164
66940/647	224	66950/730	303	66962/154*	220	639797/110	164
66940/770	225	66950/770	225	66962/160	222	639797/120	164
66940/774*	225	66950/774*	225	66962/214	219	639797/140	164
66940/847*	224	66950/847*	224	66962/306	218	639797/150	164
66945/000	224	66960/000	244	66962/770	225	639797/250	164
66945/003*	250	66960/004*	244	66962/774*	225	639797/260	164
66945/005	250	66960/005	244	66962/930	225	639797/830	164
66945/010	249	66960/010	244	66962/970	224	639797/860	164
66945/011	245	66960/011	240	66965/204	218	639797/980	164
66945/014*	249	66960/014*	244	66965/214	219		
66945/015	246	66960/015	241	66965/304	218		
66945/021	245	66960/017	231	66970/000	349		
66945/025	246	66960/021	240	66970/010	349		
66945/031	245	66960/025	241	66970/020	349		
66945/035	246	66960/027	231	66970/030	349		
66945/041	245	66960/031	240	66973/000	344		
66945/045	246	66960/035	241	66973/005	340		
66945/050	225	66960/037	231	66973/010	344		
66945/054*	225	66960/041	240	66973/015	340		
66945/071	245	66960/045	241	66973/100	346		
66945/075	246	66960/047	231	66973/110	346		
66945/081	245	66960/051	240	66975/000	336		
66945/085	246	66960/055	241	66979/003	217		
66945/121	245	66960/061	240	66979/203	215		
66945/141	245	66960/065	241	66979/215	216		
66945/145	246	66960/071	240	66979/300	215		
66945/181	245	66960/075	241	66982/000	217		
66945/185	246	66960/081	240	66982/203	218		
66945/550	249	66960/085	241	66982/214	219		
66945/554*	249	66960/111	240	66982/304	218		
66945/650	249	66960/115	241	66985/000	217		
66945/654*	249	66960/120	222	66985/004*	244		
66945/710	60	66960/121	240	66985/005	244		
66945/750*	60	66960/124*	222	66985/015	242		
66945/770	225	66960/130	221	66985/025	242		
66945/774*	225	66960/134*	221	66985/035	242		
66945/790	225	66960/140	221	66985/075	242		
66945/794*	225	66960/141	240	66985/085	242		
66945/824	227	66960/144*	221	66985/120	222		
66945/830	250	66960/145	241	66985/124*	222		
66945/834*	250	66960/150	220	66985/130	221		
66945/840*	224	66960/153*	220	66985/134*	221		
66950/000	244	66960/160	222	66985/140	221		
66950/011	240	66960/181	240	66985/144*	221		
66950/014*	244	66960/185	241	66985/150	220		
66950/015	241	66960/241	240	66985/154*	220		

**TRAMONTINA**

**TRAMONTINA FARROUPILHA S.A.**

Rodovia ERS-122, km 61  
Distrito Industrial | CEP 95178-000  
Farroupilha | RS | Brasil  
CNPJ 87.834.883/0001-13  
Indústria Brasileira



TRAMONTINA.COM.BR



/TRAMONTINA



/TRAMONTINA



/TRAMONTINA



@TRAMONTINAOFICIAL